

kunstof kozijnen en deuren
HANDYMEN POOLS
Winkel Roosendaal
www.handymen-pools.nl
info@handymen-pools.nl
☎ 0 629 016 395

Offerte online
handymenpools.nl



INTERNAL DOORS CATALOGUE 2025

Edition I/2025/C
Effective from: 1/09/2025





JASMIN 1 with facing layer STONE GREY ST CPL, with BELLA SLIM black matte handle

Every house is fitted with interior doors. This is why approaching doors only from the point of view of their functionality and practicality has long been insufficient. Underlining the best qualities in a perfectly furnished house, today they are an important component of interior design. For this reason, we create modern solutions, introduce attractive design and focus on the quality of workmanship to let you enjoy the choice of the Erkado doors.

We are committed to developing all business areas relevant for creating a product that meets your expectations. We achieve this goal by investing in technologically advanced production lines, staff training and systematic analysis of consumer needs. Our dynamic development would be impossible without the activity of the sales network participants. Thank you for your inspiring suggestions and friendly feedback.



Look for FSC® certified products

STILE DOORS			5
WERBENA NEW	6	BUDLEJA, POWOJNIK.....	24
LAURENCJA.....	8	LUKRECJA.....	26
FREZJA.....	10	EPIEDIUM.....	28
JASMIN NEW	12	ARALIA, NOLINA, EWODIA.....	30
NEMEZJA.....	14	JUKA BEST PRICE!	32
PEONIA.....	16	FORSYCJA BEST PRICE!	34
AMARYLIS.....	18	LAWENDA BEST PRICE!	36
MISKANT.....	20	IRYS.....	38
MAGNOLIA.....	22	DAGLEZJA.....	40
DEBECJA.....			42
SURMIA.....			44
BERBERYS, FLOKS.....			46
KROKUS.....			48
KAMELIA.....			50
PETUNIA.....			52
AZALIA.....			54
HIACYNT.....			56
FRAGI.....			58
LOFT GLASS DOORS NEW			60
LOFT BASIC NEW	60	LOFT CLASSIC NEW	62
LOFT ART NEW		LOFT ART NEW	64
GRAF GLASS DOORS NEW			68
DECORATIVE LAMELLAS			72
LACQUERED DOORS			74
AMARYLIS.....	74	LAURENCJA.....	82
PEONIA.....	76	BALDUR.....	84
MISKANT.....	78	ANUBIS.....	86
NEMEZJA.....	80	UNO PREMIUM.....	88
TURAN.....			90
MILDA.....			92
SYLENA.....			94
INLAYS NEW			96
FLUSH DOORS			104
BALDUR.....	104	ANSEDONIA.....	110
UNO PREMIUM.....	106	LORIENT.....	112
ALTAMURA.....	108	MENTON.....	114
SORANO.....			116
INTERNAL ENTRANCE DOORS			118
FORTECA RC2.....	118	FIXED AND ADJUSTABLE DOOR FRAME FOR	
FORTECA RC3.....	118	HERSE SET SERIES.....	126
FIXED DOOR FRAME FOR FORTECA.....	122	STEEL DOOR FRAMES FOR FORTECA HERSE SET.....	128
STEEL DOOR FRAMES FOR FORTECA.....	123	UNITED STEEL DOOR FRAME	
HERSE SET i HERSE MAX SET.....	124	FOR THE HERSE SET SERIES.....	129
EXTERNAL FIRE DOORS FOR FLATS			130
LEDA EI30.....	130	STEEL DOOR FRAMES FOR LEDA SERIES.....	132
LEDA EI60.....	130	DOUBLE LEDA EI30 & EI60.....	133
WOODEN DOOR FRAME FOR LEDA SERIES.....	132		
HARDWARE – HANDLES NEW			134
TECHNICAL INFORMATION			145
CROSSHEADS AND PILASTERS			151
DOOR FRAME EXTENSION PANELS			152
WALL-MOUNTED SLIDING DOOR SYSTEMS			154
POCKET SLIDING DOOR SYSTEMS			160
DOUBLE DOORS			163
FOLDING DOORS			166
COVERT CONCEALED DOOR SYSTEM			167
SIDELIGHTS FOR DOORS			170
DOOR FRAMES			172
TUNNEL TYPE ADJUSTABLE DOOR FRAME.....	175	REVERSE DOOR FRAME.....	179
STEEL DOOR FRAME.....	176	ADJUSTABLE DOOR FRAME FOR NON-REBATED DOORS.....	180
NON-REBATED STEEL DOOR FRAME.....	177	FIXED FRAME FOR REBATED DOORS.....	181
ADJUSTABLE CASING DOOR FRAME STEEL FRAME		ADJUSTABLE DOOR FRAME FOR REBATED DOORS.....	182
LENGTH.....	178		



FACING LAYERS

COLOURS AVAILABLE FOR INTERIOR DOORS

GREKO



GREKO WALNUT



MEDIUM GREKO OAK



GOLDEN GREKO OAK



GREKO OAK



GREKO GREY OAK



GREKO SONOMA



LIGHT ACACIA GREKO



WHITE GREKO
(similar to: RAL 9010,
NCS S 0502-Y50R)



SNOW-WHITE GREKO
(similar to: RAL 9016,
NCS S 0300-N)

PREMIUM



GRAPHITE ASH PREMIUM



OAK PREMIUM



NATUR OAK PREMIUM



NATUR OAK PREMIUM TRANSVERSE¹⁾

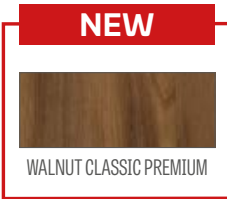

NEW

WALNUT CLASSIC PREMIUM



CONCRETE PREMIUM



GREY MAPLE PREMIUM



WHITE BARK PREMIUM



WHITE PREMIUM
(similar to: RAL 9003,
NCS S 0500-N)

CPL



WENGE DARK ST CPL



OAK ST CPL



GREY OAK ST CPL



LIGHT GREY ST CPL¹⁾
(similar to: RAL 7037,
NCS S 5500-N)



GREY ST CPL¹⁾
(similar to: RAL 7047,
NCS S 2500-N)



NEW
STONE GREY ST CPL¹⁾
(similar to: RAL 1019,
NCS S 4005-Y20R)



BLACK ST CPL¹⁾
(similar to: RAL 9011,
NCS S 9000-N)



NAVY BLUE ST CPL¹⁾
(similar to: RAL 5011,
NCS 8010-R90B)



DARK GREEN ST CPL¹⁾
(similar to: RAL 6007,
NCS S 8010-G30Y)



WHITE ST CPL^{*}
(similar to: RAL 9003,
NCS S 0500-N)



CAPPUCCINO ST CPL¹⁾
(similar to: RAL D2 080 80 05
NCS S 3005-Y50R)



NEW
SAGE ST CPL¹⁾
(similar to: RAL 7033,
NCS S 4005-G20Y)



ANTHRACITE ST CPL¹⁾
(similar to: RAL 7024
NCS S 8000-N)



ANTHRACITE SATIN CPL 0.2 & 0.7
(similar to: RAL 7024
NCS S 8000-N)



ASH-GEY CPL 0.2 & 0.7
(similar to: RAL 7047,
NCS S 2500-N)



WHITE CPL 0.2 & 0.7
(similar to: RAL 9003,
NCS S 0300-N)

UV-PAINTED



WALNUT CLASSIC CPL 0.2 & 0.7



OAK RETRO CPL 0.2 & 0.7



OAK CLASSIC CPL 0.2 & 0.7

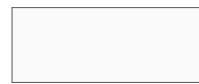

TITANIUM WHITE UV
(similar to: RAL 9003,
NCS S 0500-N)

POWDER-COATED part of the LOFT collection



BLACK STR
(RAL 9005)



WHITE STR
(RAL 9003)



RAL 5002



RAL 6005



RAL 7006



RAL 7016



RAL 7024



RAL 7032



RAL 8017



RAL 9007



RAL 9010

* special AntiFinger coating to reduce dirt and fingerprints

¹⁾ only used on selected flush doors. Comes complete with the NATUR OAK PREMIUM door frame

STILE DOORS

REBATED AND NON-REBATED



¹⁾ Available for an additional charge for rebated and non-rebated models, and the non-rebated models for sliding systems in PL and CZ standard for WHITE PREMIUM, NATUR OAK PREMIUM, GRAPHITE ASH PREMIUM, GREY MAPLE PREMIUM, OAK ST CPL



WERBENA

REBATED AND NON-REBATED INTERIOR STILE DOORS



WERBENA 1 SAGE ST CPL., with QUANTA FIT black matte handle



WERBENA 1



WERBENA 2



WERBENA 3



WERBENA 4



WERBENA 5



WERBENA 6



WERBENA 7



WERBENA 8



WERBENA 9

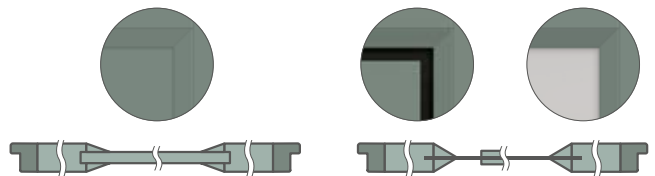

WERBENA 1, 2, 3
bevelled plate with trim
at 16 mm plate

WERBENA 4, 5, 6, 7, 8, 9
deep bevelled edge
at the glass

WERBENA 4, 5, 6
panel edge 3 mm thick,
always in black



WERBENA 4 with SAGE ST CPL facing layer; with BELLA SLIM chrome glossy handle

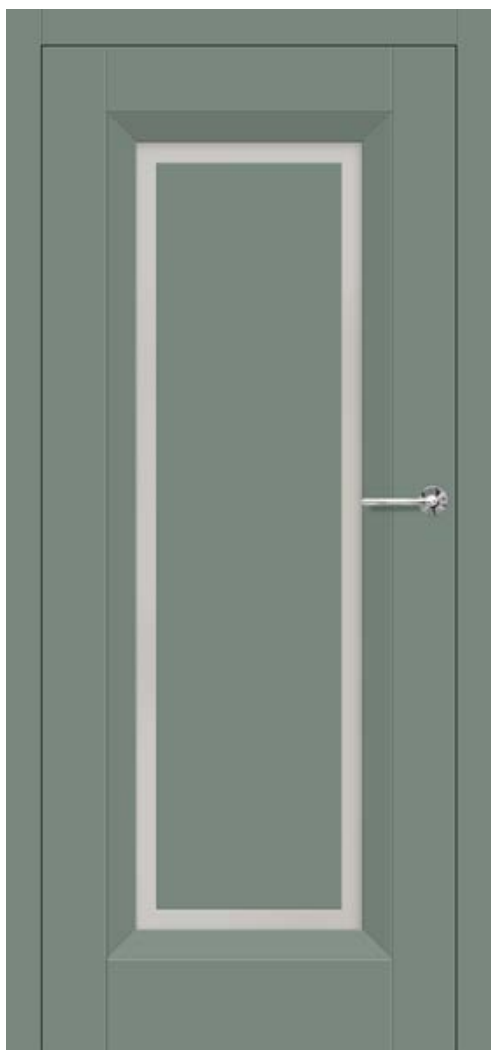

DESIGN

- rebated or non-rebated door leaf made in the STILE panelled technology
- MDF stiles and rails covered with the PREMIUM, ST CPL facings or ST CPL laminate with the AntiFinger coating
- glued laminated stiles covered with HDF and MDF boards⁴⁾
- WERBENA 1, 2, 3 – MDF panels 16 mm thick framed with slanting strip panel; WERBENA 4, 5, 6 – HDF board panels 3 mm thick on both sides to glass framed by a deep bevelled strip. **The edge of the panel is always made in black.**
- width of the gap between the bevelled strip and adhesive panel 40 mm
- optional door frame extension panels and a crosshead with pilasters are available for an additional charge, pp. 151-153
- the door can be trimmed by a customer, go to p. 149 for details

HARDWARE

- rebated door leaves: three silver 2-pin hinges adjusted horizontally
- two (third for an additional charge) concealed hinges in a non-rebated door leaf, painted in silver (optionally black, white or gold – for an additional charge); hinges supplied with and included in the price of the door frame
- latch and pin lock in a rebated door leaf and a key-locked magnetic lock (latch and pin lock as an option) in a non-rebated door leaf, thumb turn cylinder, economy, with a silver blockade; optionally, for an additional charge, a black, white or gold magnetic lock

GLAZING

- tempered 4 mm glass, frosted or clear as a standard and, for an additional charge, laminated VSG 221 safety glass frosted or black plain on both sides
- possibility to change the glazing side to REVERSE (standard glazing for OBERVERSE)

AVAILABLE SOLUTIONS (pp. 154-165)



AVAILABLE DOOR LEAF WIDTHS



ADDITIONAL CHARGES

factory pre-drilled through holes for handles (split handles) ordered together with the door leaf

enhanced airflow trim standard or mini, ventilation undercut standard or mini (p. 149)

plastic woodgrain sleeves (4 pcs)

round and square metal sleeves (4 pcs); brushed nickel or patina finish in white and black

ventilation grille (only for door leaf widths of 80, 90, 100)

"100" rebated and non-rebated door leaf

VSG 221 laminated safety glass, plain on both sides

metal hinge casings in rebated door leaf (colour: brushed nickel, patina, glossy chrome, glossy brass, white and black)

drop down seal²⁾

can be replaced with a black, white or golden magnetic lock for non-rebated door leaves

change to black lock, hinges and striker plate for rebated doors

can be changed to hinges and strike plate in black, white or gold for non-rebated door leaves

magnetic stop (buffer)²⁾ (available in six colours p. 149) (while supplies last)

glulam stiles⁴⁾

PREMIUM



CPL

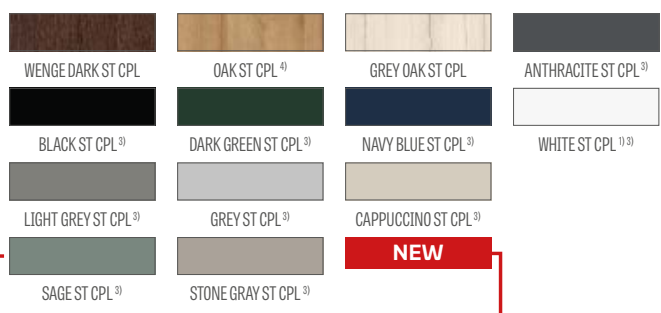

¹⁾ plain white facing imitating a painted surface
²⁾ the use of a magnetic door stop makes it impossible to use a drop down seal and a ventilation undercut, and vice versa
³⁾ special **AntiFinger** coating to reduce dirt and fingerprints
⁴⁾ glulam stiles covered with HDF and MDF boards available for WHITE PREMIUM, NATUR OAK PREMIUM, GRAPHITE ASH PREMIUM, GREY MAPLE PREMIUM, OAK ST CPL for an additional charge
⁵⁾ only for non-rebated door leaves



LAURENCJA

REBATED AND NON-REBATED INTERIOR STILE DOORS



LAURENCJA 1, with WHITE ST CPL facing layer, VSG black glass, QUANTA FIT black matte handle



LAURENCJA 1



LAURENCJA 2



LAURENCJA 3



LAURENCJA 4



LAURENCJA 5



LAURENCJA 6

LAURENCJA 1 with PREMIUM WHITE facing layer, CUBE PREMIUM black matte handle and black VSG 221 laminated glass



DESIGN

- rebated or non-rebated door leaf made in the STILE panelled technology
- MDF stiles and rails covered with the PREMIUM, ST CPL facings or ST CPL laminate with the AntiFinger coating
- glued laminated stiles covered with HDF and MDF boards⁴⁾
- 4 mm thick HDF panels with CPL or PREMIUM laminate
- very wide crossbar - 35 mm
- optional door frame extension panels and a crosshead with pilasters are available for an additional charge, pp. 151-153
- the door can be trimmed by a customer; go to p. 149 for details

HARDWARE

- rebated door leaves: three silver 2-pin hinges adjusted horizontally
- two (third for an additional charge) concealed hinges in a non-rebated door leaf, painted in silver (optionally black, white or gold – for an additional charge); hinges supplied with and included in the price of the door frame
- latch and pin lock in a rebated door leaf and a key-locked magnetic lock (latch and pin lock as an option) in a non-rebated door leaf, thumb turn cylinder, economy, with a silver blockade; optionally, for an additional charge, a black, white or gold magnetic lock

GLAZING

- 4 mm glass, frosted or clear as a standard and, for an additional charge, laminated VSG 221 safety glass frosted or black plain on both sides
- possibility to change the glazing side to REVERSE (standard glazing for OBVERSE)

AVAILABLE SOLUTIONS (pp. 154-165)

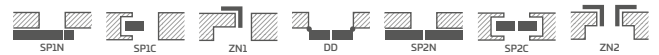

AVAILABLE DOOR LEAF WIDTHS



PREMIUM



CPL

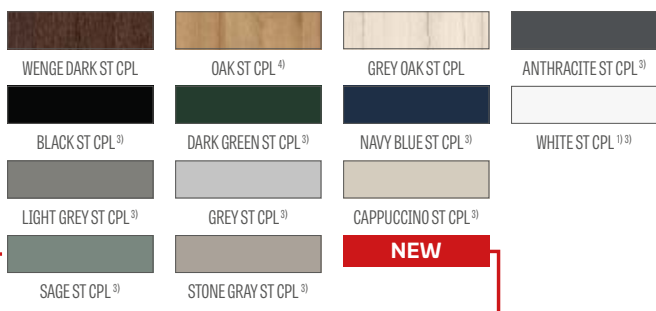

Glulam stiles⁴⁾

ADDITIONAL CHARGES

factory pre-drilled through holes for handles (split handles) ordered together with the door leaf

enhanced airflow trim standard or mini, ventilation undercut standard or mini (p. 149)

plastic woodgrain sleeves (4 pcs)

round and square metal sleeves (4 pcs); brushed nickel or patina finish in white and black

ventilation grille (only for door leaf widths of 80, 90, 100)

"100" rebated and non-rebated door leaf

VSG 221 laminated safety glass, plain on both sides

metal hinge casings in rebated door leaf

(colour: brushed nickel, patina, glossy chrome, glossy brass, white and black)

drop down seal²⁾

can be replaced with a black, white or golden magnetic lock for non-rebated door leaves

change to black lock, hinges and striker plate for rebated doors

can be changed to hinges and strike plate in black, white or gold for non-rebated door leaves

magnetic stop (buffer)²⁾

(available in six colours p. 149) (while supplies last)

glulam stiles⁴⁾

¹⁾ plain white facing imitating a painted surface

²⁾ the use of a magnetic door stop makes it impossible to use a drop down seal and a ventilation undercut, and vice versa

³⁾ special **AntiFinger** coating to reduce dirt and fingerprints

⁴⁾ glulam stiles covered with HDF and MDF boards available for WHITE PREMIUM, NATUR OAK PREMIUM, GRAPHITE ASH PREMIUM, GREY MAPLE PREMIUM, OAK ST CPL for an additional charge

⁵⁾ only for non-rebated door leaves



FREZJA

REBATED AND NON-REBATED INTERIOR STILE DOORS



FREZJA 9 with CAPUCCINO ST CPL facing layer, with BELLA SLIM glossy brass handle



FREZJA 1



FREZJA 2



FREZJA 3



FREZJA 4

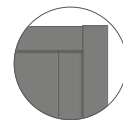

FREZJA 2

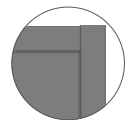

FREZJA 4

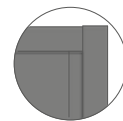

FREZJA 6



FREZJA 9
panel edge 3 mm thick,
always in black



FREZJA 5



FREZJA 6



FREZJA 7 ³⁾



FREZJA 8 ²⁾



FREZJA 8
ventilation undercut

²⁾ FREZJA 8 – 8 mm thick glazing

³⁾ FREZJA 7 – model only with a mirror; the other side –
aboard covered in a given facing layer.
Obverse – a mirror fitted on the hinge side
(as shown in the photo)

FREZJA 9⁸⁾ with LIGHT GREY ST CPL facing layer with QUANTA FIT black matte handle



DESIGN

- rebated or non-rebated door leaf made in the STILE panelled technology
- vertical and horizontal stiles made of MDF covered with GREKO, PREMIUM, ST CPL facings or ST CPL laminate with the AntiFinger coating
- glued laminated stiles covered with HDF and MDF boards⁶⁾
- 16 mm thick HDF panels (also a 4 mm panel for the FREZJA 2 & 6 models) covered with the GREKO, CPL or PREMIUM facing; FREZJA 7 is available with a mirror only
- in FREZJA 9 model, the panel is made HDF board 3 mm thick, applied to glass on both sides. **The edge of the panel is always made in black.**
- optional door frame extension panels and a crosshead with pilasters are available for an additional charge, pp. 151-153
- the door can be trimmed by a customer, go to p. 149 for details

HARDWARE

- rebated door leaves: three silver 2-pin hinges adjusted horizontally
- two (third for an additional charge) concealed hinges in a non-rebated door leaf, painted in silver (optionally black, white or gold – for an additional charge); hinges supplied with and included in the price of the door frame
- latch and pin lock in a rebated door leaf and a key-locked magnetic lock (latch and pin lock as an option) in a non-rebated door leaf, thumb turn cylinder, economy, with a silver blockade; optionally, for an additional charge, a black, white or gold magnetic lock

GLAZING

- frosted tempered glass as a standard, 4 mm transparent or mirror on one side (only FREZJA 7) and for an additional charge: VSG221 laminated glass, frosted or black safety glass, plain on both sides (for FREZJA 1, 3, 5) or decorative tempered glass 4 mm relief and point **NEW** (for FREZJA 1, 3, 5). Relief and point glass are smooth on one side.
- possibility to change the glazing side to REVERSE (standard glazing for OBVERSE)
- fixed glazing width; FREZJA 1 – 140 mm, FREZJA 5 – 70 mm, FREZJA 9 – 50 mm

GREKO⁸⁾

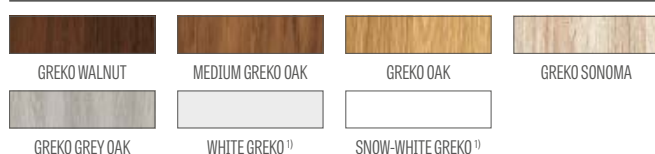

PREMIUM⁸⁾

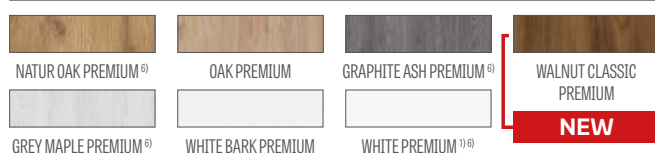

CPL⁸⁾

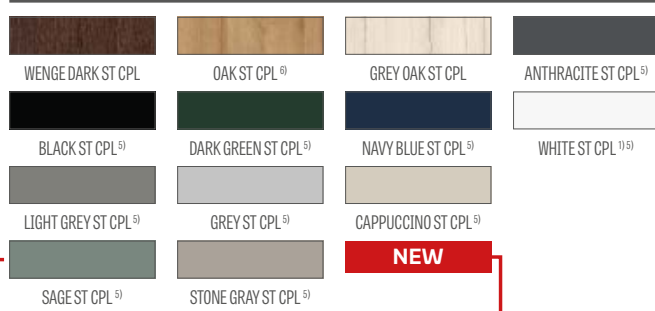

¹⁾ plain white facing imitating a painted surface

²⁾ not available in FREZJA 8

³⁾ FREZJA 8 is not available for sliding systems

⁴⁾ the use of a magnetic door stop makes it impossible to use a drop down seal and a ventilation undercut, and vice versa

⁵⁾ special **AntiFinger** coating to reduce dirt and fingerprints

⁶⁾ glulam stiles covered with HDF and MDF boards available for WHITE PREMIUM, NATUR OAK PREMIUM, GRAPHITE ASH PREMIUM, GREY MAPLE PREMIUM, OAK ST CPL for an additional charge

⁷⁾ only for non-rebated door leaves

⁸⁾ **FREZJA 9 model available with PREMIUM and ST CPL facing layers**

⁹⁾ not available for GREKO facing layers

AVAILABLE SOLUTIONS (pp. 154-165)



AVAILABLE DOOR LEAF WIDTHS



ADDITIONAL CHARGES

factory pre-drilled through holes for handles (split handles) ordered together with the door leaf

enhanced airflow trim standard or mini, ventilation undercut standard or mini (p. 149)

plastic woodgrain sleeves (4 pcs)²⁾

round and square metal sleeves²⁾ (4 pcs.); brushed nickel or patina finish white and black

ventilation grille²⁾ (only for door leaf widths of: 80, 90, 100)

"100" rebated and non-rebated door leaf

VSG 221 laminated safety glass, clear on both sides or decorative glass

metal hinge casings in the rebated door leaf (brushed nickel, patina, polished chrome, polished brass, white and black)

drop down seal⁴⁾ (not for FREZJA 8)

can be replaced with a black, white or golden magnetic lock for non-rebated door leaves

change to black lock, hinges and striker plate for rebated doors

can be changed to hinges and strike plate in black, white or gold for non-rebated door leaves

magnetic stop (buffer)⁴⁾

(available in six colours p. 149) (while supplies last)

glulam stiles⁶⁾

PL2112 standard⁹⁾

+15% on the door price before additional charges



JASMIN

REBATED AND NON-REBATED INTERIOR STILE DOORS



JASMIN 3 with CAPPUCCINO ST CPL facing layer, BELLA SLIM black matte handle



JASMIN 1



JASMIN 2



JASMIN 3



JASMIN 4



JASMIN 5^{*)}



JASMIN 6^{*)}



JASMIN 7^{*)}



JASMIN 8^{*)}



JASMIN
panel edge 3 mm thick,
always in black

^{*)} The photos of the JASMIN 5-8 doors shown here only show the „80” door leaf width. For other widths, there are differences in the radius of the center panel relative to the glass, which may influence the customer's choice. Graphics illustrating the individual widths are available at www.erkado.pl

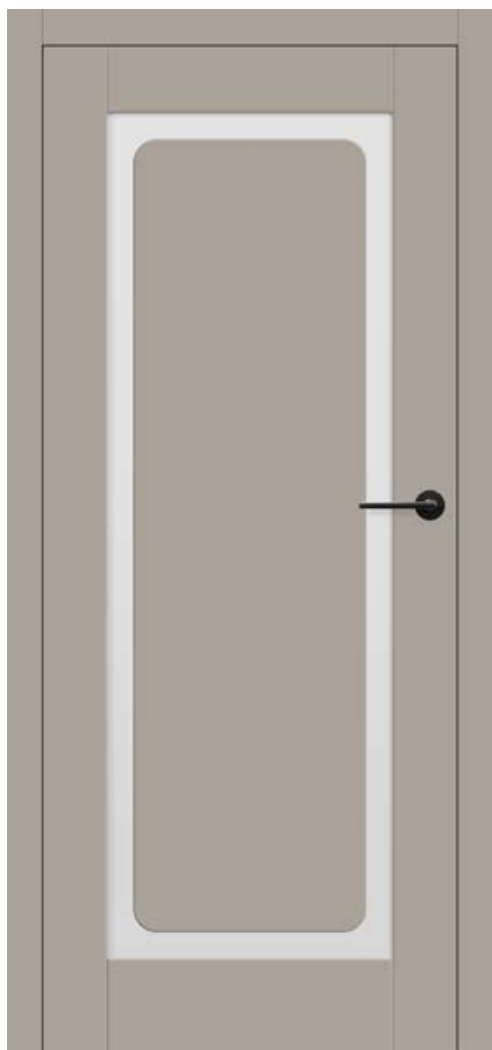

JASMIN 1 with facing layer STONE GREY ST CPL, with BELLA SLIM black matte handle

DESIGN

- rebated or non-rebated door leaf made in the STILE panelled technology
- MDF stiles and rails covered with the PREMIUM, ST CPL facings or ST CPL laminate with the AntiFinger coating
- glued laminated stiles covered with HDF and MDF boards⁴⁾
- HDF boards 3 mm thick, applied to glass on both sides. **The edge of the panel is always made in black.**
- the transparency between the edge of the frame and the panel to be bonded is 50 mm
- optional door frame extension panels and a crosshead with pilasters are available for an additional charge, pp. 151-153
- the door can be trimmed by a customer, go to p. 149 for details

HARDWARE

- rebated door leaves: three silver 2-pin hinges adjusted horizontally
- two (third for an additional charge) concealed hinges in a non-rebated door leaf, painted in silver (optionally black, white or gold – for an additional charge); hinges supplied with and included in the price of the door frame
- latch and pin lock in a rebated door leaf and a key-locked magnetic lock (latch and pin lock as an option) in a non-rebated door leaf, thumb turn cylinder, economy, with a silver blockade; optionally, for an additional charge, a black, white or gold magnetic lock

GLAZING

- tempered 4 mm glass, frosted or clear as a standard and, for an additional charge, laminated VSG 221 safety glass frosted or black plain on both sides
- possibility to change the glazing side to REVERSE (standard glazing for OBERVERSE)

AVAILABLE SOLUTIONS (pp. 154-165)



AVAILABLE DOOR LEAF WIDTHS



ADDITIONAL CHARGES

factory pre-drilled through holes for handles (split handles) ordered together with the door leaf

enhanced airflow trim standard or mini, ventilation undercut standard or mini (p. 149)

plastic woodgrain sleeves (4 pcs)

round and square metal sleeves (4 pcs); brushed nickel or patina finish in white and black

ventilation grille (only for door leaf widths of 80, 90, 100)

"100" rebated and non-rebated door leaf

VSG 221 laminated safety glass, plain on both sides

metal hinge casings in rebated door leaf (colour: brushed nickel, patina, glossy chrome, glossy brass, white and black)

drop down seal²⁾

can be replaced with a black, white or golden magnetic lock for non-rebated door leaves

change to black lock, hinges and striker plate for rebated doors

can be changed to hinges and strike plate in black, white or gold for non-rebated door leaves

magnetic stop (buffer)²⁾ (available in six colours p. 149) (while supplies last)

glulam stiles⁴⁾

PREMIUM



CPL

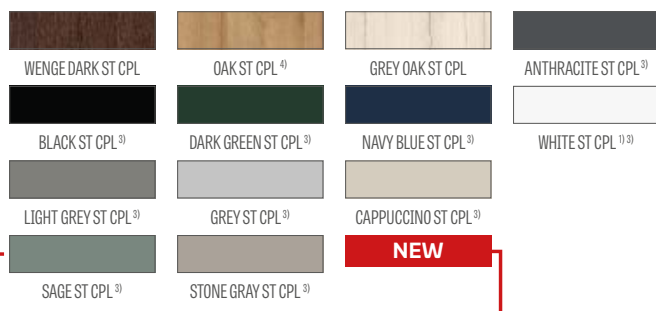

Glulam stiles⁴⁾

¹⁾ plain white facing imitating a painted surface
²⁾ the use of a magnetic door stop makes it impossible to use a drop down seal and a ventilation undercut, and vice versa
³⁾ special **AntiFinger** coating to reduce dirt and fingerprints
⁴⁾ glulam stiles covered with HDF and MDF boards available for WHITE PREMIUM, NATUR OAK PREMIUM, GRAPHITE ASH PREMIUM, GREY MAPLE PREMIUM, OAK ST CPL for an additional charge
⁵⁾ only for non-rebated door leaves



NEMEZJA

REBATED AND NON-REBATED INTERIOR STILE DOORS



NEMEZJA 14 with ANTHRACITE ST CPL facing layer, QUANTA FIT black matte handle



NEMEZJA 4



NEMEZJA 6



NEMEZJA 7



NEMEZJA 8



NEMEZJA 9

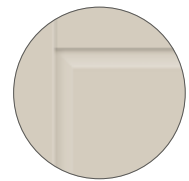

Chamfered panel



NEMEZJA 10



NEMEZJA 11



NEMEZJA 12



NEMEZJA 15



NEMEZJA 16

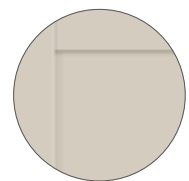

NEMEZJA 16
Straight panel

NEMEZJA 16 with ANTHRACITE ST CPL facing layer, QUANTA FT black matte handle



NEW

DESIGN

- rebated or non-rebated door leaf made in the STILE panelled technology
- vertical and horizontal stiles made of MDF covered with GREKO, PREMIUM, ST CPL facings or ST CPL laminate with the AntiFinger coating
- glued laminated stiles covered with HDF and MDF boards⁴⁾
- bevelled 16 mm thick HDF and plain panels (only NEMEZJA 16) with a selection of GREKO, CPL or PREMIUM facing
- optional door frame extension panels and a crosshead with pilasters are available for an additional charge, pp. 151-153
- the door can be trimmed by a customer; go to p. 149 for details

HARDWARE

- rebated door leaves: three silver 2-pin hinges adjusted horizontally
- two (third for an additional charge) concealed hinges in a non-rebated door leaf, painted in silver (optionally black, white or gold – for an additional charge); hinges supplied with and included in the price of the door frame
- latch and pin lock in a rebated door leaf and a key-locked magnetic lock (latch and pin lock as an option) in a non-rebated door leaf, thumb turn cylinder, economy, with a silver blockade; optionally, for an additional charge, a black, white or gold magnetic lock

GLAZING

- tempered 4 mm glass, frosted or clear as a standard and, for an additional charge, laminated VSG 221 safety glass frosted or black plain on both sides, or decorative tempered glass 4 mm relief and point **NEW** for NEMEZJA 4, 7, 11, 15 (Relief and point glass are smooth on one side)
- possibility to change the glazing side to REVERSE (standard glazing for OBVERSE)

AVAILABLE SOLUTIONS (pp. 154-165)



AVAILABLE DOOR LEAF WIDTHS



GREKO



PREMIUM



CPL

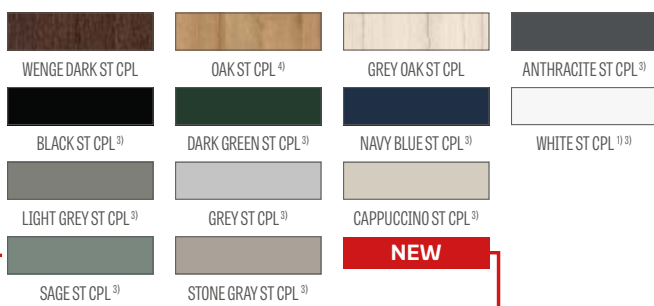

Glulam stiles⁴⁾

ADDITIONAL CHARGES

factory pre-drilled through holes for handles (split handles) ordered together with the door leaf

enhanced airflow trim standard or mini, ventilation undercut standard or mini (p. 149)

plastic woodgrain sleeves (4 pcs)

round and square metal sleeves (4 pcs); brushed nickel or patina finish in white and black

ventilation grille (only for door leaf widths of 80, 90, 100)

"100" rebated and non-rebated door leaf

VSG 221 laminated safety glass, clear on both sides or decorative glass

metal hinge casings in the rebated door leaf (brushed nickel, patina, polished chrome, polished brass, white and black)

drop down seal²⁾

can be replaced with a black, white or golden magnetic lock for non-rebated door leaves

change to black lock, hinges and striker plate for rebated doors

can be changed to hinges and strike plate in black, white or gold for non-rebated door leaves

magnetic stop (buffer)²⁾

(available in six colours p. 149) (while supplies last)

glulam stiles⁴⁾

PL2112 standard³⁾

+15% on the door price before additional charges

¹⁾ plain white facing imitating a painted surface

²⁾ the use of a magnetic door stop makes it impossible to use a drop down seal and a ventilation undercut, and vice versa

³⁾ special **AntiFinger** coating to reduce dirt and fingerprints

⁴⁾ glulam stiles covered with HDF and MDF boards available for WHITE PREMIUM, NATUR OAK PREMIUM, GRAPHITE ASH PREMIUM, GREY MAPLE PREMIUM, OAK ST CPL for an additional charge

⁵⁾ only for non-rebated door leaves

⁷⁾ decorative crosshead with pilasters for an additional charge, p. 151

⁶⁾ not available for GREKO facing layers



PEONIA

REBATED AND NON-REBATED INTERIOR STILE DOORS



PEONIA 2 with SAGE ST CPL facing layer, with frosted glass, with BELLA SLIM glossy brass handle, with decorative crosshead and pilasters⁶⁾



PEONIA 1



PEONIA 2



PEONIA 3



PEONIA 4



PEONIA 5



PEONIA 6



Double-sided stick-on muntin 25 mm
in leaf colour or black

PEONIA 3 with SAGE ST CPL facing layer, with CUBE PREMIUM black matte handle, with decorative crosshead and pilasters⁶⁾



DESIGN

- rebated or non-rebated door leaf made in the STILE panelled technology
- vertical and horizontal stiles made of MDF covered with GREKO, PREMIUM, ST CPL facings or ST CPL laminate with the AntiFinger coating
- glued laminated stiles covered with HDF and MDF boards⁴⁾
- bevelled 16 mm thick HDF panels with a selection of GREKO, CPL or PREMIUM facing
- double-sided muntin applied to glass, 25 mm wide and of respective heights: vertical 12 mm and horizontal 8 mm
- optional change of muntin facing layer to the BLACK ST CPL colour regardless of the leaf facing layer
- optional door frame extension panels and a crosshead with pilasters are available for an additional charge, pp. 151-153
- the door can be trimmed by a customer, go to p. 149 for details

HARDWARE

- rebated door leaves: three silver 2-pin hinges adjusted horizontally
- two (third for an additional charge) concealed hinges in a non-rebated door leaf, painted in silver (optionally black, white or gold – for an additional charge); hinges supplied with and included in the price of the door frame
- latch and pin lock in a rebated door leaf and a key-locked magnetic lock (latch and pin lock as an option) in a non-rebated door leaf, thumb turn cylinder, economy, with a silver blockade; optionally, for an additional charge, a black, white or gold magnetic lock

GLAZING

- tempered 4 mm glass, frosted or clear as a standard and, for an additional charge, laminated VSG 221 safety glass frosted or black plain on both sides, or decorative tempered glass 4 mm relief and point **NEW** (Relief and point glass are smooth on one side)
- possibility to change the glazing side to REVERSE (standard glazing for OBERSE)

GREKO

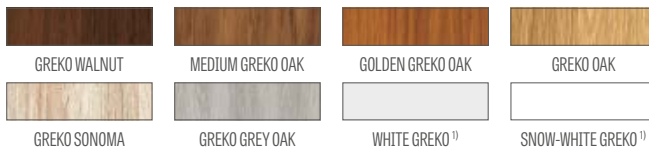

PREMIUM



CPL

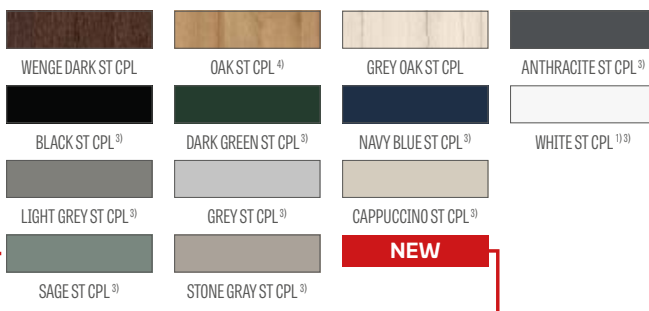

Glulam stiles⁴⁾

¹⁾ plain white facing imitating a painted surface

²⁾ the use of a magnetic door stop makes it impossible to use a drop down seal and a ventilation undercut, and vice versa

³⁾ special **AntiFinger** coating to reduce dirt and fingerprints

⁴⁾ glulam stiles covered with HDF and MDF boards available for WHITE PREMIUM, NATUR OAK PREMIUM, GRAPHITE ASH PREMIUM, GREY MAPLE PREMIUM, OAK ST CPL for an additional charge

⁵⁾ only for non-rebated door leaves

⁶⁾ decorative crosshead with pilasters for an additional charge, p. 151

⁶⁾ not available for GREKO facing layers

AVAILABLE SOLUTIONS (pp. 154-165)



AVAILABLE DOOR LEAF WIDTHS



ADDITIONAL CHARGES

factory pre-drilled through holes for handles (split handles) ordered together with the door leaf

enhanced airflow trim standard or mini, ventilation undercut standard or mini (p. 149)

plastic woodgrain sleeves (4 pcs)

round and square metal sleeves (4 pcs); brushed nickel or patina finish in white and black

ventilation grille (only for door leaf widths of 80, 90, 100)

"100" rebated and non-rebated door leaf

VSG 221 laminated safety glass, clear on both sides or decorative glass

metal hinge casings in the rebated door leaf (brushed nickel, patina, polished chrome, polished brass, white and black)

drop down seal²⁾

can be replaced with a black, white or golden magnetic lock for non-rebated door leaves

change to black lock, hinges and striker plate for rebated doors

can be changed to hinges and strike plate in black, white or gold for non-rebated door leaves

magnetic stop (buffer)²⁾

(available in six colours p. 149) (while supplies last)

glulam stiles⁴⁾

PL2112 standard⁶⁾

+15% on the door price before additional charges



AMARYLIS

REBATED AND NON-REBATED INTERIOR STILE DOORS



AMARYLIS 2 with STONE GREY ST CPL facing layer, with decorative relief glazing, with BELLA SLIM glossy brass handle, with decorative crosshead and pilasters⁷⁾



AMARYLIS 1

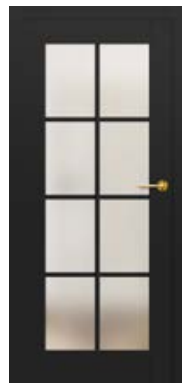

AMARYLIS 2



AMARYLIS 3



AMARYLIS 4



AMARYLIS 5



AMARYLIS 6



AMARYLIS 7



AMARYLIS 8



AMARYLIS 9



Double-sided stick-on muntin 25 mm
in leaf colour or black

AMARYLIS 3 with OAK NATUR PREMIUM facing layer, with BELLA SLIM black matte handle



DESIGN

- rebated or non-rebated door leaf made in the STILE panelled technology
- vertical and horizontal stiles made of MDF covered with GREKO, PREMIUM, ST CPL facings or ST CPL laminate with the AntiFinger coating
- glued laminated stiles covered with HDF and MDF boards⁴⁾
- double-sided muntin applied to glass, 25 mm wide and of respective heights: vertical 12 mm and horizontal 8 mm
- optional change of muntin facing layer to the BLACK ST CPL colour regardless of the leaf facing layer
- optional door frame extension panels and a crosshead with pilasters are available for an additional charge, pp. 151-153
- the door can be trimmed by a customer, go to p. 149 for details

HARDWARE

- rebated door leaves: three silver 2-pin hinges adjusted horizontally
- two (third for an additional charge) concealed hinges in a non-rebated door leaf, painted in silver (optionally black, white or gold – for an additional charge); hinges supplied with and included in the price of the door frame
- latch and pin lock in a rebated door leaf and a key-locked magnetic lock (latch and pin lock as an option) in a non-rebated door leaf, thumb turn cylinder, economy, with a silver blockade; optionally, for an additional charge, a black, white or gold magnetic lock

GLAZING

- tempered 4 mm glass, frosted or clear as a standard and, for an additional charge, laminated VSG 221 safety glass frosted or black plain on both sides, or decorative tempered glass 4 mm relief and point **NEW** (Relief and point glass are smooth on one side)
- possibility to change the glazing side to REVERSE (standard glazing for OBERSE)

GREKO

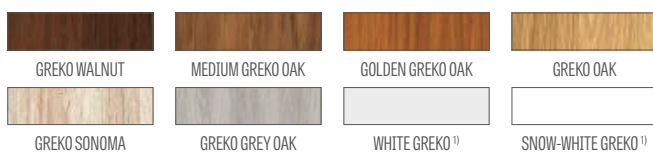

PREMIUM



CPL

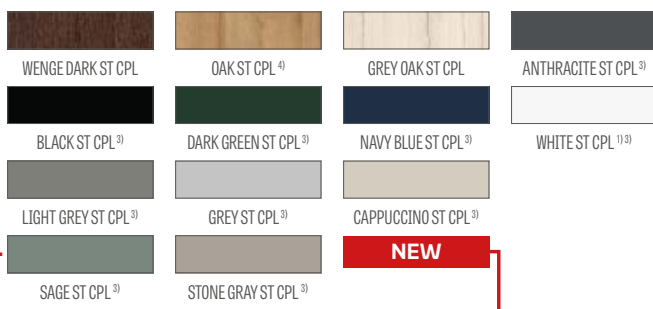

Glulam stiles⁴⁾

¹⁾ plain white facing imitating a painted surface

²⁾ the use of a magnetic door stop makes it impossible to use a drop down seal and a ventilation undercut, and vice versa

³⁾ special **AntiFinger** coating to reduce dirt and fingerprints

⁴⁾ glulam stiles covered with HDF and MDF boards available for WHITE PREMIUM, NATUR OAK PREMIUM, GRAPHITE ASH PREMIUM, GREY MAPLE PREMIUM, OAK ST CPL for an additional charge

⁵⁾ only for non-rebated door leaves

⁷⁾ decorative crosshead with pilasters for an additional charge, p. 151

⁸⁾ not available for GREKO facing layers

AVAILABLE SOLUTIONS (pp. 154-165)



AVAILABLE DOOR LEAF WIDTHS



ADDITIONAL CHARGES

factory pre-drilled through holes for handles (split handles) ordered together with the door leaf

VSG 221 laminated safety glass, clear on both sides or decorative glass

enhanced airflow trim standard or mini, ventilation undercut standard or mini (p. 149)

plastic woodgrain sleeves (4 pcs)

round and square metal sleeves (4 pcs); brushed nickel or patina finish in white and black

ventilation grille (only for door leaf widths of 80, 90, 100)

"100" rebated and non-rebated door leaf

metal hinge casings in the rebated door leaf (brushed nickel, patina, polished chrome, polished brass, white and black)

drop down seal²⁾

can be replaced with a black, white or golden magnetic lock for non-rebated door leaves

change to black lock, hinges and striker plate for rebated doors

can be changed to hinges and strike plate in black, white or gold for non-rebated door leaves

magnetic stop (buffer)²⁾

(available in six colours p. 149) (while supplies last)

glulam stiles⁴⁾

PL2112 standard⁸⁾

+15% on the door price before additional charges



MISKANT

REBATED AND NON-REBATED INTERIOR STILE DOORS



MISKANT 2 with NATUR OAK PREMIUM facing layer; frame with BLACK ST CPL facing layer; BELLA SLIM black matte handle



MISKANT 1



MISKANT 2

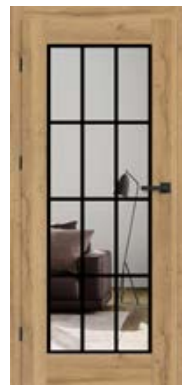

MISKANT 3



Black lines 18 mm wide
silk-screen painted



MISKANT 4



MISKANT 5



MISKANT 6

MISKANT 3 with NATUR OAK PREMIUM facing layer, frame with BLACK ST CPL facing layer, CUBE black matte handle

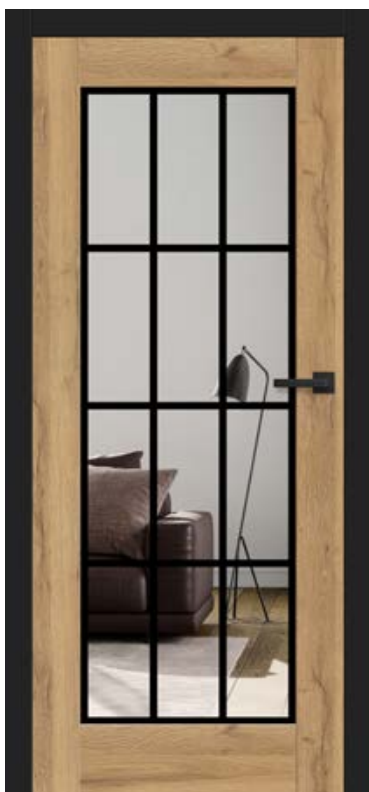

DESIGN

- rebated or non-rebated door leaf made in the STILE panelled technology
- vertical and horizontal stiles made of MDF covered with GREKO, PREMIUM, ST CPL facings or ST CPL laminate with the AntiFinger coating
- glued laminated stiles covered with HDF and MDF boards⁴⁾
- optional door frame extension panels and a crosshead with pilasters are available for an additional charge, pp. 151-153
- the door can be trimmed by a customer, go to p. 149 for details

HARDWARE

- rebated door leaves: three silver 2-pin hinges adjusted horizontally
- two (third for an additional charge) concealed hinges in a non-rebated door leaf, painted in silver (optionally black, white or gold – for an additional charge); hinges supplied with and included in the price of the door frame
- latch and pin lock in a rebated door leaf and a key-locked magnetic lock (latch and pin lock as an option) in a non-rebated door leaf, thumb turn cylinder, economy, with a silver blockade; optionally, for an additional charge, a black, white or gold magnetic lock

GLAZING

- tempered frosted glass (MISKANT 2, 4, 6) or clear glass (MISKANT 1, 3, 5), 4 mm thick or, for an additional charge, VSG clear laminated glass with internal decorative pattern
- possibility to change the glazing side to REVERSE (standard glazing for OBERSE)
- black lines, 18 mm wide (thickness), screen printed on one side of the glazing

AVAILABLE SOLUTIONS (pp. 154-165)



AVAILABLE DOOR LEAF WIDTHS



GREKO

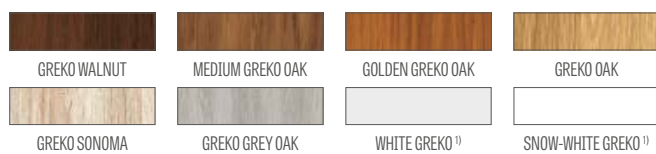

PREMIUM



CPL

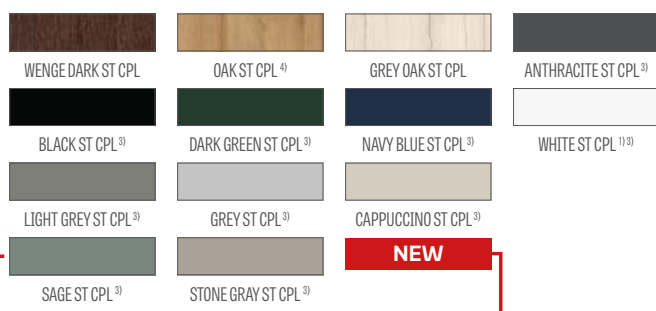

Glulam stiles⁴⁾

STANDARD "OBERSE" GLAZING



"REVERSE" GLAZING MADE TO ORDER



ADDITIONAL CHARGES

factory pre-drilled through holes for handles (split handles) ordered together with the door leaf

VSG laminated clear glass with internal decorative pattern in black or white

enhanced airflow trim standard or mini, ventilation undercut standard or mini (p. 149)

plastic woodgrain sleeves (4 pcs)

round and square metal sleeves (4 pcs); brushed nickel or patina finish in white and black

ventilation grille (only for door leaf widths of 80, 90, 100)

"100" rebated and non-rebated door leaf

metal hinge casings in the rebated door leaf (brushed nickel, patina, polished chrome, polished brass, white and black)

drop down seal²⁾

can be replaced with a black, white or golden magnetic lock for non-rebated door leaves

change to black lock, hinges and striker plate for rebated doors

can be changed to hinges and strike plate in black, white or gold for non-rebated door leaves

magnetic stop (buffer)²⁾

(available in six colours p. 149) (while supplies last)

glulam stiles⁴⁾

¹⁾ plain white facing imitating a painted surface

²⁾ the use of a magnetic door stop makes it impossible to use a drop down seal and a ventilation undercut, and vice versa

³⁾ special **AntiFinger** coating to reduce dirt and fingerprints

⁴⁾ glulam stiles covered with HDF and MDF boards available for WHITE PREMIUM, NATUR OAK PREMIUM, GRAPHITE ASH PREMIUM, GREY MAPLE PREMIUM, OAK ST CPL for an additional charge

⁵⁾ only for non-rebated door leaves



MAGNOLIA

REBATED AND NON-REBATED INTERIOR STILE DOORS



MAGNOLIA 1 with OAK PREMIUM facing layer and TOPAZ stainless steel handle



MAGNOLIA 1



MAGNOLIA 2



MAGNOLIA 3



MAGNOLIA 4



MAGNOLIA 5



MAGNOLIA 6



MAGNOLIA 7



MAGNOLIA 8

MAGNOLIA 1 with OAK PREMIUM facing layer and TOPAZ stainless steel handle



DESIGN

- rebated or non-rebated door leaf made in the STILE panelled technology
- vertical and horizontal stiles made of MDF covered with GREKO, PREMIUM, ST CPL facings or ST CPL laminate with the AntiFinger coating
- glued laminated stiles covered with HDF and MDF boards⁴⁾
- 4 mm thick HDF panels with GREKO, CPL or PREMIUM finish
- optional door frame extension panels and a crosshead with pilasters are available for an additional charge, pp. 151-153
- the door can be trimmed by a customer; go to p. 149 for details

HARDWARE

- rebated door leaves: three silver 2-pin hinges adjusted horizontally
- two (third for an additional charge) concealed hinges in a non-rebated door leaf, painted in silver (optionally black, white or gold – for an additional charge); hinges supplied with and included in the price of the door frame
- latch and pin lock in a rebated door leaf and a key-locked magnetic lock (latch and pin lock as an option) in a non-rebated door leaf, thumb turn cylinder, economy, with a silver blockade; optionally, for an additional charge, a black, white or gold magnetic lock

GLAZING

- tempered 4 mm glass, frosted or clear as a standard and, for an additional charge, laminated VSG 221 safety glass frosted or black plain on both sides
- possibility to change the glazing side to REVERSE (standard glazing for OBVERSE)

AVAILABLE SOLUTIONS (pp. 154-165)



AVAILABLE DOOR LEAF WIDTHS



GREKO

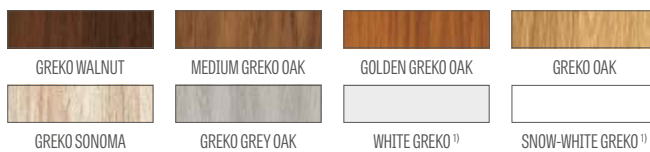

PREMIUM



CPL

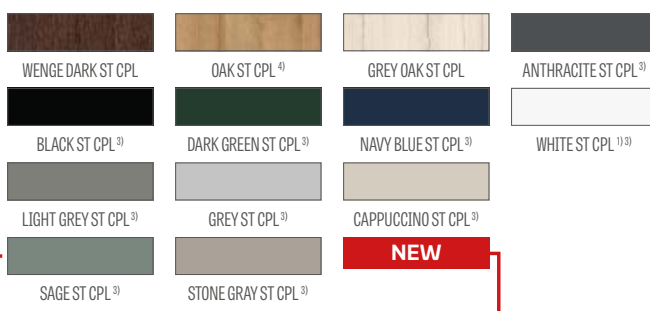

Glulam stiles⁴⁾

ADDITIONAL CHARGES

factory pre-drilled through holes for handles (split handles) ordered together with the door leaf

enhanced airflow trim standard or mini, ventilation undercut standard or mini (p. 149)

plastic woodgrain sleeves (4 pcs)

round and square metal sleeves (4 pcs); brushed nickel or patina finish in white and black

ventilation grille (only for door leaf widths of 80, 90, 100)

"100" rebated and non-rebated door leaf

VSG 221 laminated safety glass, plain on both sides

metal hinge casings in rebated door leaf (colour: brushed nickel, patina, glossy chrome, glossy brass, white and black)

drop down seal²⁾

can be replaced with a black, white or golden magnetic lock for non-rebated door leaves

change to black lock, hinges and striker plate for rebated doors

can be changed to hinges and strike plate in black, white or gold for non-rebated door leaves

magnetic stop (buffer)²⁾ (available in six colours p. 149) (while supplies last)

glulam stiles⁴⁾

PL2112 standard⁷⁾ + 15% on the door price before additional charges

¹⁾ plain white facing imitating a painted surface

²⁾ the use of a magnetic door stop makes it impossible to use a drop down seal and a ventilation undercut, and vice versa

³⁾ special **AntiFinger** coating to reduce dirt and fingerprints

⁴⁾ glulam stiles covered with HDF and MDF boards available for WHITE PREMIUM, NATUR OAK PREMIUM, GRAPHITE ASH PREMIUM, GREY MAPLE PREMIUM, OAK ST CPL for an additional charge

⁵⁾ only for non-rebated door leaves



BUDLEJA, POWOJNIK

REBATED AND NON-REBATED INTERIOR STILE DOORS



BUDLEJA 8 with WALNUT CLASSIC PREMIUM facing layer, with BELLA SLIM glossy brass handle



BUDLEJA 1



BUDLEJA 2



BUDLEJA 4



BUDLEJA 6



BUDLEJA 8



POWOJNIK 1



POWOJNIK 2



POWOJNIK 3

BUDLEJA 1 with WALNUT CLASSIC PREMIUM facing layer, with BELLA SLIM glossy brass handle



DESIGN

- rebated or non-rebated door leaf made in the STILE panelled technology
- MDF stiles and rails covered with the PREMIUM, ST CPL facings or ST CPL laminate with the AntiFinger coating
- glued laminated stiles covered with HDF and MDF boards⁴⁾
- 4 mm thick HDF panels with CPL or PREMIUM laminate (POWOJNIK)
- very wide crossbar - 35 mm
- optional door frame extension panels and a crosshead with pilasters are available for an additional charge, pp. 151-153
- the door can be trimmed by a customer; go to p. 149 for details

HARDWARE

- rebated door leaves: three silver 2-pin hinges adjusted horizontally
- two (third for an additional charge) concealed hinges in a non-rebated door leaf, painted in silver (optionally black, white or gold – for an additional charge); hinges supplied with and included in the price of the door frame
- latch and pin lock in a rebated door leaf and a key-locked magnetic lock (latch and pin lock as an option) in a non-rebated door leaf, thumb turn cylinder, economy, with a silver blockade; optionally, for an additional charge, a black, white or gold magnetic lock

GLAZING

- tempered 4 mm glass, frosted or clear as a standard and, for an additional charge, laminated VSG 221 safety glass frosted or black plain on both sides
- possibility to change the glazing side to REVERSE (standard glazing for OBVERSE)

AVAILABLE SOLUTIONS (pp. 154-165)



AVAILABLE DOOR LEAF WIDTHS



PREMIUM



CPL

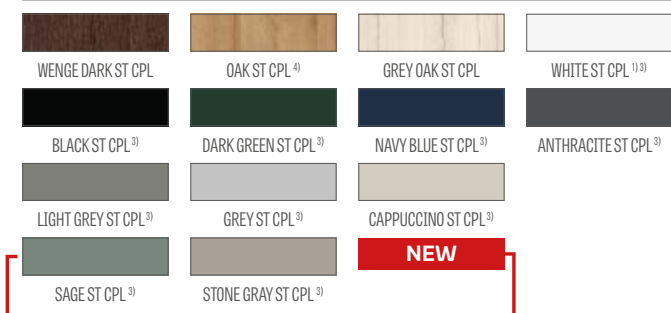

Glulam stiles⁴⁾

ADDITIONAL CHARGES

factory pre-drilled through holes for handles (split handles) ordered together with the door leaf

enhanced airflow trim standard or mini, ventilation undercut standard or mini (p. 149)

plastic woodgrain sleeves (4 pcs)

round and square metal sleeves (4 pcs); brushed nickel or patina finish in white and black

ventilation grille (only for door leaf widths of 80, 90, 100)

"100" rebated and non-rebated door leaf

VSG 221 laminated safety glass, plain on both sides

metal hinge casings in rebated door leaf

(colour: brushed nickel, patina, glossy chrome, glossy brass, white and black)

drop down seal²⁾

can be replaced with a black, white or golden magnetic lock for non-rebated door leaves

change to black lock, hinges and striker plate for rebated doors

can be changed to hinges and strike plate in black, white or gold for non-rebated door leaves

magnetic stop (buffer)²⁾

(available in six colours p. 149) (while supplies last)

glulam stiles⁴⁾

¹⁾ plain white facing imitating a painted surface

²⁾ the use of a magnetic door stop makes it impossible to use a drop down seal and a ventilation undercut, and vice versa

³⁾ special **AntiFinger** coating to reduce dirt and fingerprints

⁴⁾ glulam stiles covered with HDF and MDF boards available for WHITE PREMIUM, NATUR OAK PREMIUM, GRAPHITE ASH PREMIUM, GREY MAPLE PREMIUM, OAK ST CPL for an additional charge

⁵⁾ only for non-rebated door leaves



LUKRECJA

REBATED AND NON-REBATED INTERIOR STILE DOORS



LUKRECJA 1 with OAK NATUR PREMIUM facing layer; with transparent glazing, with BELLA SLIM glossy brass handle



LUKRECJA 1



LUKRECJA 2



LUKRECJA 3



LUKRECJA 4



LUKRECJA 5



LUKRECJA 6



LUKRECJA 7



LUKRECJA 8



LUKRECJA 9



Double-sided stick-on muntin 25 mm wide
in leaf colour or black

LUKRECJA 1 with ST CPL OAK facing layer, BELLA SLIM satin brass handle

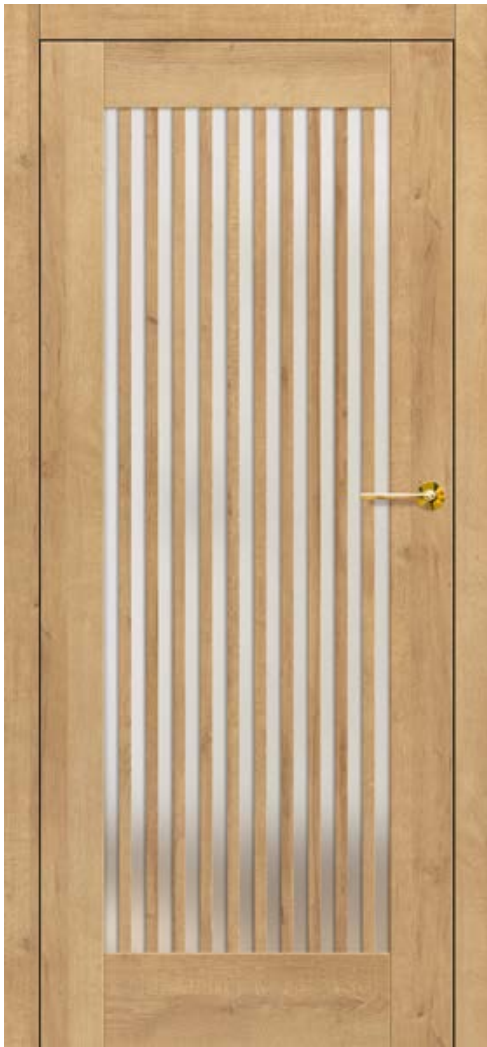

DESIGN

- rebated or non-rebated door leaf made in the STILE panelled technology
- MDF stiles and rails covered with the PREMIUM, ST CPL facings or ST CPL laminate with the AntiFinger coating
- glued laminated stiles covered with HDF and MDF boards⁴⁾
- double-sided muntin applied to glass, 25mm wide and 12mm high
- optional change of muntin facing layer to the BLACK ST CPL colour regardless of the leaf facing layer
- optional door frame extension panels and a crosshead with pilasters are available for an additional charge, pp. 151-153
- the door can be trimmed by a customer, go to p. 149 for details

HARDWARE

- rebated door leaves: three silver 2-pin hinges adjusted horizontally
- two (third for an additional charge) concealed hinges in a non-rebated door leaf, painted in silver (optionally black, white or gold – for an additional charge); hinges supplied with and included in the price of the door frame
- latch and pin lock in a rebated door leaf and a key-locked magnetic lock (latch and pin lock as an option) in a non-rebated door leaf, thumb turn cylinder, economy, with a silver blockade; optionally, for an additional charge, a black, white or gold magnetic lock

GLAZING

- tempered 4 mm glass, frosted or clear as a standard and, for an additional charge, laminated VSG 221 safety glass frosted or black plain on both sides
- possibility to change the glazing side to REVERSE (standard glazing for OBERVERSE)

AVAILABLE SOLUTIONS (pp. 154-165)



AVAILABLE DOOR LEAF WIDTHS

60 65 70 75 80N⁵⁾ 80 85 90 95 100

PREMIUM



CPL

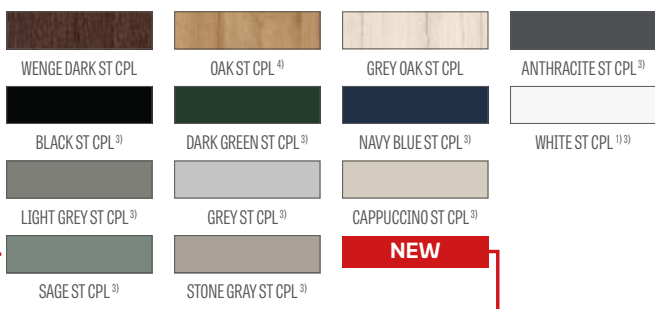

Glulam stiles⁴⁾

¹⁾ plain white facing imitating a painted surface

²⁾ the use of a magnetic door stop makes it impossible to use a drop down seal and a ventilation undercut, and vice versa

³⁾ special **AntiFinger** coating to reduce dirt and fingerprints

⁴⁾ glulam stiles covered with HDF and MDF boards available for WHITE PREMIUM, NATUR OAK PREMIUM, GRAPHITE ASH PREMIUM, GREY MAPLE PREMIUM, OAK ST CPL for an additional charge

⁵⁾ only for non-rebated door leaves

ADDITIONAL CHARGES

factory pre-drilled through holes for handles (split handles) ordered together with the door leaf

VSG 221 laminated safety glass, plain on both sides

enhanced airflow trim standard or mini, ventilation undercut standard or mini (p. 149)

plastic woodgrain sleeves (4 pcs)

round and square metal sleeves (4 pcs); brushed nickel or patina finish in white and black

ventilation grille (only for door leaf widths of 80, 90, 100)

"100" rebated and non-rebated door leaf

metal hinge casings in the rebated door leaf (brushed nickel, patina, polished chrome, polished brass, white and black)

drop down seal²⁾

can be replaced with a black, white or golden magnetic lock for non-rebated door leaves

change to black lock, hinges and striker plate for rebated doors

can be changed to hinges and strike plate in black, white or gold for non-rebated door leaves

magnetic stop (buffer)²⁾

(available in six colours p. 149) (while supplies last)

glulam stiles⁴⁾

PL2112 standard

+15% on the door price before additional charges



EPIMEDIUM

REBATED AND NON-REBATED INTERIOR STILE DOORS



EPIMEDIUM 6 with GREY ST CPL facing layer, VSG black glass, QUANTA FIT black matte handle

WIDTH 80



EPIMEDIUM 1^{*)}



EPIMEDIUM 2^{*)}



EPIMEDIUM 3^{*)}



EPIMEDIUM 4^{*)}



EPIMEDIUM 6^{*)}

WIDTH 70



EPIMEDIUM 1^{*)}



EPIMEDIUM 2^{*)}



EPIMEDIUM 3^{*)}



EPIMEDIUM 4^{*)}



EPIMEDIUM 6^{*)}

^{*)} The pictures show only the EPIMEDIUM doors with 80 and 70 cm wide leaves.

The glazing to vertical bars ratio in the other width options differs considerably, which can be the key factor regarding the customer's product choice.

For the other width options go to www.erkado.pl

EPIMEDIUM 6 with GREY ST CPL facing layer with QUANTA FIT black matte handle, VSG glass, black



DESIGN

- rebated or non-rebated door leaf made in the STILE panelled technology
- vertical and horizontal stiles made of MDF covered with GREKO, PREMIUM, ST CPL facings or ST CPL laminate with the AntiFinger coating
- glued laminated stiles covered with HDF and MDF boards⁴⁾
- 4 mm thick HDF panels with GREKO, CPL or PREMIUM finish
- narrow, long crossbar of 22 mm
- optional door frame extension panels and a crosshead with pilasters are available for an additional charge, pp. 151-153
- the door can be trimmed by a customer; go to p. 149 for details

HARDWARE

- rebated door leaves: three silver 2-pin hinges adjusted horizontally
- two (third for an additional charge) concealed hinges in a non-rebated door leaf, painted in silver (optionally black, white or gold – for an additional charge); hinges supplied with and included in the price of the door frame
- latch and pin lock in a rebated door leaf and a key-locked magnetic lock (latch and pin lock as an option) in a non-rebated door leaf, thumb turn cylinder, economy, with a silver blockade; optionally, for an additional charge, a black, white or gold magnetic lock

GLAZING

- tempered 4 mm glass, frosted or clear as a standard and, for an additional charge, laminated VSG 221 safety glass frosted or black plain on both sides
- possibility to change the glazing side to REVERSE (standard glazing for OBVERSE)
- depending on the leaf width, the glazing widths differ.
Check at www.erkado.pl

AVAILABLE SOLUTIONS (pp. 154-165)



GREKO

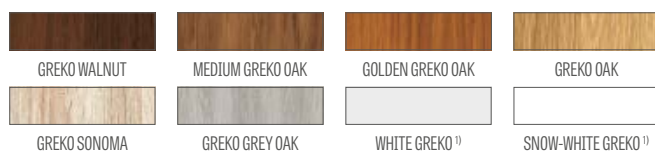

PREMIUM



CPL

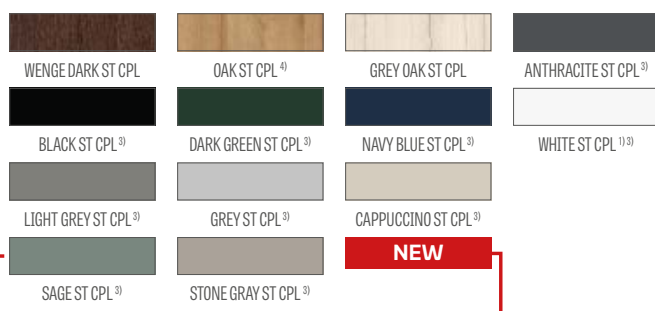

AVAILABLE DOOR LEAF WIDTHS



ADDITIONAL CHARGES

factory pre-drilled through holes for handles (split handles) ordered together with the door leaf

enhanced airflow trim standard or mini, ventilation undercut standard or mini (p. 149)

plastic woodgrain sleeves (4 pcs)

round and square metal sleeves (4 pcs); brushed nickel or patina finish in white and black

ventilation grille (only for door leaf widths of 80, 90, 100)

"100" rebated and non-rebated door leaf

VSG 221 laminated safety glass, plain on both sides

metal hinge casings in the rebated door leaf (brushed nickel, patina, polished chrome, polished brass, white and black)

drop down seal²⁾

can be replaced with a black, white or golden magnetic lock for non-rebated door leaves

change to black lock, hinges and striker plate for rebated doors

can be changed to hinges and strike plate in black, white or gold for non-rebated door leaves

magnetic stop (buffer)²⁾
(available in six colours p. 149) (while supplies last)

glulam stiles⁴⁾

¹⁾ plain white facing imitating a painted surface

²⁾ the use of a magnetic door stop makes it impossible to use a drop down seal and a ventilation undercut, and vice versa

³⁾ special **AntiFinger** coating to reduce dirt and fingerprints

⁴⁾ glulam stiles covered with HDF and MDF boards available for WHITE PREMIUM, NATUR OAK PREMIUM, GRAPHITE ASH PREMIUM, GREY MAPLE PREMIUM, OAK ST CPL for an additional charge

⁵⁾ only for non-rebated door leaves



ARALIA NOLINA EWODIA

REBATED AND NON-REBATED INTERIOR STILE DOORS



NOLINA 1 with WHITE BARK PREMIUM facing layer, CUBE black matte handle



ARALIA 1²⁾



NOLINA 1



EWODIA 1²⁾



EWODIA 2²⁾



EWODIA 4²⁾

NOLINA 1, with WHITE BARK PREMIUM facing layer with CUBE black matte handle



DESIGN

- rebated or non-rebated door leaf made in the STILE panelled technology
- MDF stiles and rails covered with the PREMIUM facing
- glued laminated stiles covered with HDF and MDF boards²⁾
- 16 mm thick HDF panels with PREMIUM facing layer (vertical grain direction)
- optional door frame extension panels and a crosshead with pilasters are available for an additional charge, pp. 151-153
- the door can be trimmed by a customer, go to p. 149 for details

HARDWARE

- rebated door leaves: three silver 2-pin hinges adjusted horizontally
- two (third for an additional charge) concealed hinges in a non-rebated door leaf, painted in silver (optionally black, white or gold – for an additional charge); hinges supplied with and included in the price of the door frame
- latch and pin lock in a rebated door leaf and a key-locked magnetic lock (latch and pin lock as an option) in a non-rebated door leaf, thumb turn cylinder, economy, with a silver blockade; optionally, for an additional charge, a black, white or gold magnetic lock

GLAZING

- frosted decormat glass, 4 mm, or custom-made frosted or black VSG 221 laminated safety glass, plain on both sides
- possibility to change the glazing side to REVERSE (standard glazing for OBVERSE)

AVAILABLE SOLUTIONS (pp. 154-165)

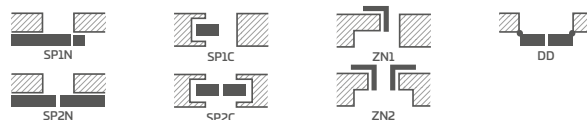

AVAILABLE DOOR LEAF WIDTHS

60 70 80N³⁾ 80 90 100

PREMIUM



ADDITIONAL CHARGES

factory pre-drilled through holes for handles (split handles) ordered together with the door leaf

enhanced airflow trim standard or mini, ventilation undercut standard or mini (p. 149)

plastic woodgrain sleeves (4 pcs)

round and square metal sleeves (4 pcs); brushed nickel or patina finish in white and black

ventilation grille (only for door leaf widths of 80, 90, 100)

"100" rebated and non-rebated door leaf

VSG 221 laminated safety glass, plain on both sides

metal hinge casings in rebated door leaf

(colour: brushed nickel, patina, glossy chrome, glossy brass, white and black)

drop down seal¹⁾

can be replaced with a black, white or golden magnetic lock for non-rebated door leaves

change to black lock, hinges and striker plate for rebated doors

can be changed to hinges and strike plate in black, white or gold for non-rebated door leaves

magnetic stop (buffer)¹⁾

(available in six colours p. 149) (while supplies last)

glulam stiles²⁾



Glulam stiles²⁾

¹⁾ the use of a magnetic door stop makes it impossible to use a drop down seal and a ventilation undercut, and vice versa

²⁾ glulam stiles covered with HDF and MDF boards available for an additional charge in ARALIA 1, EWODIA 1, 2, 4 models for NATUR OAK PREMIUM, GRAPHITE ASH PREMIUM, GRAPHITE MAPLE PREMIUM

³⁾ only for non-rebated door leaves



JUKA

REBATED AND NON-REBATED INTERIOR STILE DOORS



JUKA 3 with DAß ST CPL facing layer, TOPAZ stainless steel handle



JUKA 1



JUKA 2



JUKA 3



JUKA 4



JUKA 5



JUKA 6



JUKA 7



JUKA 8

JUKKA 1 with DARK GREEN ST CPL facing layer with BELLA SLIM glossy brass handle



DESIGN

- rebated or non-rebated door leaf made in the STILE panelled technology
- vertical and horizontal stiles made of MDF covered with GREKO, PREMIUM, ST CPL facings or ST CPL laminate with the AntiFinger coating
- glued laminated stiles covered with HDF and MDF boards⁴⁾
- 4 mm thick HDF panels with GREKO, CPL or PREMIUM finish
- optional door frame extension panels and a crosshead with pilasters are available for an additional charge, pp. 151-153
- the door can be trimmed by a customer, go to p. 149 for details

HARDWARE

- rebated door leaves: three silver 2-pin hinges adjusted horizontally
- two (third for an additional charge) concealed hinges in a non-rebated door leaf, painted in silver (optionally black, white or gold – for an additional charge); hinges supplied with and included in the price of the door frame
- latch and pin lock in a rebated door leaf and a key-locked magnetic lock (latch and pin lock as an option) in a non-rebated door leaf, thumb turn cylinder, economy, with a silver blockade; optionally, for an additional charge, a black, white or gold magnetic lock

GLAZING

- tempered 4 mm glass, frosted or clear as a standard and, for an additional charge, laminated VSG 221 safety glass frosted or black plain on both sides
- possibility to change the glazing side to REVERSE (standard glazing for OBVERSE)

AVAILABLE SOLUTIONS (pp. 154-165)

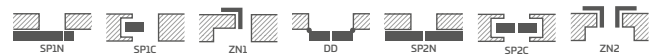

AVAILABLE DOOR LEAF WIDTHS



GREKO



PREMIUM



CPL

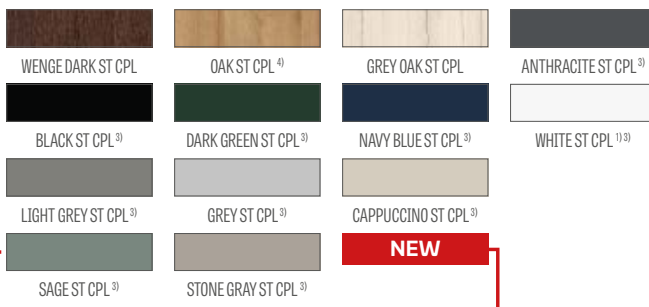

Glulam stiles⁴⁾

ADDITIONAL CHARGES

factory pre-drilled through holes for handles (split handles) ordered together with the door leaf

enhanced airflow trim standard or mini, ventilation undercut standard or mini (p. 149)

plastic woodgrain sleeves (4 pcs)

round and square metal sleeves (4 pcs); brushed nickel or patina finish in white and black

ventilation grille (only for door leaf widths of 80, 90, 100)

"100" rebated and non-rebated door leaf

VSG 221 laminated safety glass, plain on both sides

metal hinge casings in the rebated door leaf (brushed nickel, patina, polished chrome, polished brass, white and black)

drop down seal²⁾

can be replaced with a black, white or golden magnetic lock for non-rebated door leaves

change to black lock, hinges and striker plate for rebated doors

can be changed to hinges and strike plate in black, white or gold for non-rebated door leaves

magnetic stop (buffer)²⁾

(available in six colours p. 149) (while supplies last)

glulam stiles⁴⁾

¹⁾ plain white facing imitating a painted surface

²⁾ the use of a magnetic door stop makes it impossible to use a drop down seal and a ventilation undercut, and vice versa

³⁾ special **AntiFinger** coating to reduce dirt and fingerprints

⁴⁾ glulam stiles covered with HDF and MDF boards available for WHITE PREMIUM, NATUR OAK PREMIUM, GRAPHITE ASH PREMIUM, GREY MAPLE PREMIUM, OAK ST CPL for an additional charge

⁵⁾ only for non-rebated door leaves



FORSYCJA

REBATED AND NON-REBATED INTERIOR STILE DOORS



FORSYCJA 1 with WHITE GREKO facing layer, BELLA SLIM black matte handle



FORSYCJA 1



FORSYCJA 2



FORSYCJA 3



FORSYCJA 4



FORSYCJA 5



FORSYCJA 6



FORSYCJA 7



FORSYCJA 8

FORSYCJA 4 with WHITE GREKO facing layer and a CUBE black matte handle



DESIGN

- rebated or non-rebated door leaf made in the STILE panelled technology
- vertical and horizontal stiles made of MDF covered with GREKO, PREMIUM, ST CPL facings or ST CPL laminate with the AntiFinger coating
- glued laminated stiles covered with HDF and MDF boards ⁴⁾
- 4 mm thick HDF panels with GREKO, CPL or PREMIUM finish
- optional door frame extension panels and a crosshead with pilasters are available for an additional charge, pp. 151-153
- the door can be trimmed by a customer, go to p. 149 for details

HARDWARE

- rebated door leaves: three silver 2-pin hinges adjusted horizontally
- two (third for an additional charge) concealed hinges in a non-rebated door leaf, painted in silver (optionally black, white or gold – for an additional charge); hinges supplied with and included in the price of the door frame
- latch and pin lock in a rebated door leaf and a key-locked magnetic lock (latch and pin lock as an option) in a non-rebated door leaf, thumb turn cylinder, economy, with a silver blockade; optionally, for an additional charge, a black, white or gold magnetic lock

GLAZING

- tempered 4 mm glass, frosted or clear as a standard and, for an additional charge, laminated VSG 221 safety glass frosted or black plain on both sides
- possibility to change the glazing side to REVERSE (standard glazing for OBVERSE)

AVAILABLE SOLUTIONS (pp. 154-165)

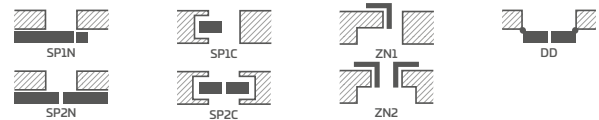

AVAILABLE DOOR LEAF WIDTHS



GREKO



PREMIUM



CPL

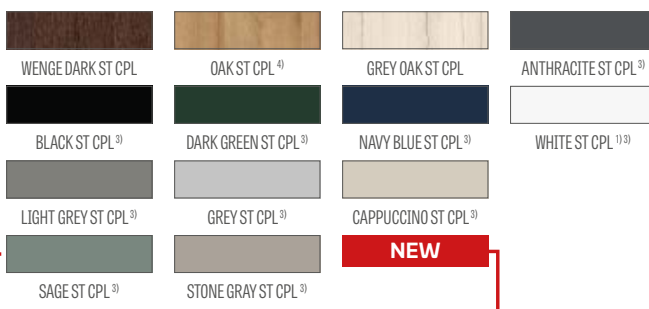

ADDITIONAL CHARGES

factory pre-drilled through holes for handles (split handles) ordered together with the door leaf

enhanced airflow trim standard or mini, ventilation undercut standard or mini (p. 149)

plastic woodgrain sleeves (4 pcs)

round and square metal sleeves (4 pcs); brushed nickel or patina finish in white and black

ventilation grille (only for door leaf widths of 80, 90, 100)

"100" rebated and non-rebated door leaf

VSG 221 laminated safety glass, plain on both sides

metal hinge casings in the rebated door leaf (brushed nickel, patina, polished chrome, polished brass, white and black)

drop down seal ²⁾

can be replaced with a black, white or golden magnetic lock for non-rebated door leaves

change to black lock, hinges and striker plate for rebated doors

can be changed to hinges and strike plate in black, white or gold for non-rebated door leaves

magnetic stop (buffer) ²⁾

(available in six colours p. 149) (while supplies last)

glulam stiles ⁴⁾

¹⁾ plain white facing imitating a painted surface

²⁾ the use of a magnetic door stop makes it impossible to use a drop down seal and a ventilation undercut, and vice versa

³⁾ special **AntiFinger** coating to reduce dirt and fingerprints

⁴⁾ glulam stiles covered with HDF and MDF boards available for WHITE PREMIUM, NATUR OAK PREMIUM, GRAPHITE ASH PREMIUM, GREY MAPLE PREMIUM, OAK ST CPL for an additional charge

⁵⁾ only for non-rebated door leaves



LAWENDA

REBATED AND NON-REBATED INTERIOR STILE DOORS



LAWENDA 7 with GREKO OAK facing layer; with DECO handle



LAWENDA 1



LAWENDA 2



LAWENDA 3



LAWENDA 4



LAWENDA 5



LAWENDA 6



LAWENDA 7



LAWENDA 8



LAWENDA 9

LAWENDA 1 with GREKO OAK facing layer, with DECO handle



DESIGN

- rebated or non-rebated door leaf made in the STILE panelled technology
- vertical and horizontal stiles made of MDF covered with GREKO, PREMIUM, ST CPL facings or ST CPL laminate with the AntiFinger coating
- glued laminated stiles covered with HDF and MDF boards⁴⁾
- 4 mm thick HDF panels with GREKO, CPL or PREMIUM finish
- optional door frame extension panels and a crosshead with pilasters are available for an additional charge, pp. 151-153
- the door can be trimmed by a customer, go to p. 149 for details

HARDWARE

- rebated door leaves: three silver 2-pin hinges adjusted horizontally
- two (third for an additional charge) concealed hinges in a non-rebated door leaf, painted in silver (optionally black, white or gold – for an additional charge); hinges supplied with and included in the price of the door frame
- latch and pin lock in a rebated door leaf and a key-locked magnetic lock (latch and pin lock as an option) in a non-rebated door leaf, thumb turn cylinder, economy, with a silver blockade; optionally, for an additional charge, a black, white or gold magnetic lock

GLAZING

- tempered 4 mm glass, frosted or clear as a standard and, for an additional charge, laminated VSG 221 safety glass frosted or black plain on both sides
- possibility to change the glazing side to REVERSE (standard glazing for OBERSE)

AVAILABLE SOLUTIONS (pp. 154-165)



AVAILABLE DOOR LEAF WIDTHS



GREKO



PREMIUM



CPL

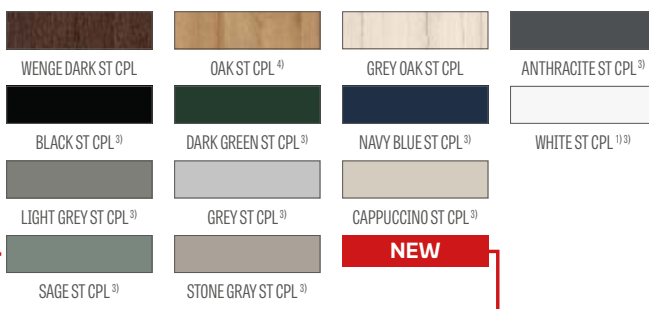

Glulam stiles⁴⁾

ADDITIONAL CHARGES

factory pre-drilled through holes for handles (split handles) ordered together with the door leaf

enhanced airflow trim standard or mini, ventilation undercut standard or mini (p. 149)

plastic woodgrain sleeves (4 pcs)

round and square metal sleeves (4 pcs); brushed nickel or patina finish in white and black

ventilation grille (only for door leaf widths of 80, 90, 100)

"100" rebated and non-rebated door leaf

VSG 221 laminated safety glass, plain on both sides

metal hinge casings in the rebated door leaf (brushed nickel, patina, polished chrome, polished brass, white and black)

drop down seal²⁾

can be replaced with a black, white or golden magnetic lock for non-rebated door leaves

change to black lock, hinges and striker plate for rebated doors

can be changed to hinges and strike plate in black, white or gold for non-rebated door leaves

magnetic stop (buffer)²⁾
(available in six colours p. 149) (while supplies last)

glulam stiles⁴⁾

¹⁾ plain white facing imitating a painted surface

²⁾ the use of a magnetic door stop makes it impossible to use a drop down seal and a ventilation undercut, and vice versa

³⁾ special **AntiFinger** coating to reduce dirt and fingerprints

⁴⁾ glulam stiles covered with HDF and MDF boards available for WHITE PREMIUM, NATUR OAK PREMIUM, GRAPHITE ASH PREMIUM, GREY MAPLE PREMIUM, OAK ST CPL for an additional charge

⁵⁾ only for non-rebated door leaves



IRYS

REBATED AND NON-REBATED INTERIOR STILE DOORS



IRYS 1 with WHITE ST CPL facing layer, handle: CUBE, black matte



IRYS 1



IRYS 2



IRYS 3



IRYS 4



IRYS 5



IRYS 6



IRYS 7



IRYS 8

IRYS 1 with GREY ST CPL facing layer with QUANTA FIT black matte handle



DESIGN

- rebated or non-rebated door leaf made in the STILE panelled technology
- vertical and horizontal stiles made of MDF covered with GREKO, PREMIUM, ST CPL facings or ST CPL laminate with the AntiFinger coating
- glued laminated stiles covered with HDF and MDF boards⁴⁾
- 4 mm thick HDF panels with GREKO, CPL or PREMIUM finish
- optional door frame extension panels and a crosshead with pilasters are available for an additional charge, pp. 151-153
- the door can be trimmed by a customer, go to p. 149 for details

HARDWARE

- rebated door leaves: three silver 2-pin hinges adjusted horizontally
- two (third for an additional charge) concealed hinges in a non-rebated door leaf, painted in silver (optionally black, white or gold – for an additional charge); hinges supplied with and included in the price of the door frame
- latch and pin lock in a rebated door leaf and a key-locked magnetic lock (latch and pin lock as an option) in a non-rebated door leaf, thumb turn cylinder, economy, with a silver blockade; optionally, for an additional charge, a black, white or gold magnetic lock

GLAZING

- tempered 4 mm glass, frosted or clear as a standard and, for an additional charge, laminated VSG 221 safety glass frosted or black plain on both sides
- possibility to change the glazing side to REVERSE (standard glazing for OBVERSE)

AVAILABLE SOLUTIONS (pp. 154-165)

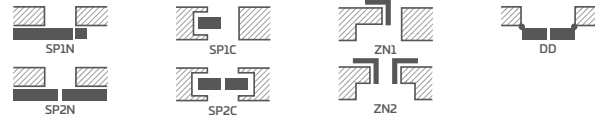

GREKO



PREMIUM



CPL

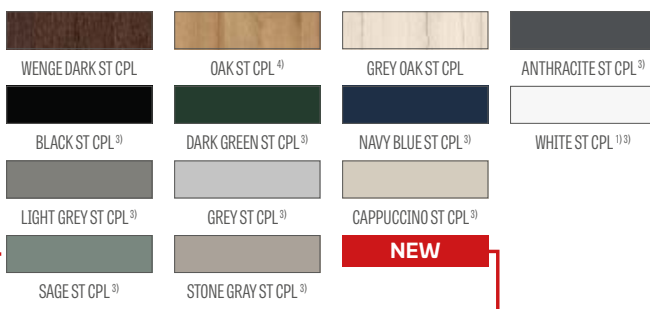

Glulam stiles⁴⁾

¹⁾ plain white facing imitating a painted surface

²⁾ the use of a magnetic door stop makes it impossible to use a drop down seal and a ventilation undercut, and vice versa

³⁾ special **AntiFinger** coating to reduce dirt and fingerprints

⁴⁾ glulam stiles covered with HDF and MDF boards available for WHITE PREMIUM, NATUR OAK PREMIUM, GRAPHITE ASH PREMIUM, GREY MAPLE PREMIUM, OAK ST CPL for an additional charge

⁵⁾ only for non-rebated door leaves

AVAILABLE DOOR LEAF WIDTHS



ADDITIONAL CHARGES

factory pre-drilled through holes for handles (split handles) ordered together with the door leaf

enhanced airflow trim standard or mini, ventilation undercut standard or mini (p. 149)

plastic woodgrain sleeves (4 pcs)

round and square metal sleeves (4 pcs); brushed nickel or patina finish in white and black

ventilation grille (only for door leaf widths of 80, 90, 100)

"100" rebated and non-rebated door leaf

VSG 221 laminated safety glass, plain on both sides

metal hinge casings in rebated door leaf

(colour: brushed nickel, patina, glossy chrome, glossy brass, white and black)

drop down seal²⁾

can be replaced with a black, white or golden magnetic lock for non-rebated door leaves

change to black lock, hinges and striker plate for rebated doors

can be changed to hinges and strike plate in black, white or gold for non-rebated door leaves

magnetic stop (buffer)²⁾

(available in six colours p. 149) (while supplies last)

glulam stiles⁴⁾



DAGLEZJA

REBATED AND NON-REBATED INTERIOR STILE DOORS



DAGLEZJA 1 with ANTHRACITE ST CPL facing layer and a CUBE brushed matte chrome handle



DAGLEZJA 1



DAGLEZJA 2



DAGLEZJA 3



DAGLEZJA 4



DAGLEZJA 5



DAGLEZJA 6



DAGLEZJA 7



DAGLEZJA 8

DAGLEZJA 6 with ANTHRACITE ST CPL facing layer and a CUBE brushed matte chrome handle



DESIGN

- rebated or non-rebated door leaf made in the STILE panelled technology
- vertical and horizontal stiles made of MDF covered with GREKO, PREMIUM, ST CPL facings or ST CPL laminate with the AntiFinger coating
- glued laminated stiles covered with HDF and MDF boards⁴⁾
- 4 mm thick HDF panels with GREKO, CPL or PREMIUM finish
- very wide crossbar
- optional door frame extension panels and a crosshead with pilasters are available for an additional charge, pp. 151-153
- the door can be trimmed by a customer; go to p. 149 for details

HARDWARE

- rebated door leaves: three silver 2-pin hinges adjusted horizontally
- two (third for an additional charge) concealed hinges in a non-rebated door leaf, painted in silver (optionally black, white or gold – for an additional charge); hinges supplied with and included in the price of the door frame
- latch and pin lock in a rebated door leaf and a key-locked magnetic lock (latch and pin lock as an option) in a non-rebated door leaf, thumb turn cylinder, economy, with a silver blockade; optionally, for an additional charge, a black, white or gold magnetic lock

GLAZING

- 4 mm glass, frosted or clear as a standard and, for an additional charge, laminated VSG 221 safety glass frosted or black plain on both sides
- possibility to change the glazing side to REVERSE (standard glazing for OBERSE)

AVAILABLE SOLUTIONS (pp. 154-165)

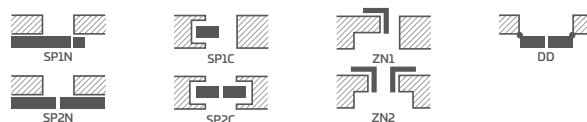

AVAILABLE DOOR LEAF WIDTHS



GREKO



PREMIUM

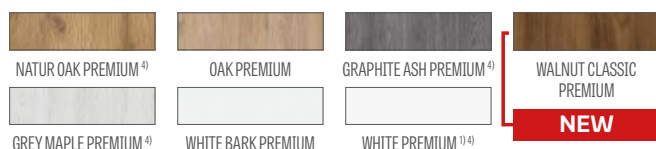

CPL

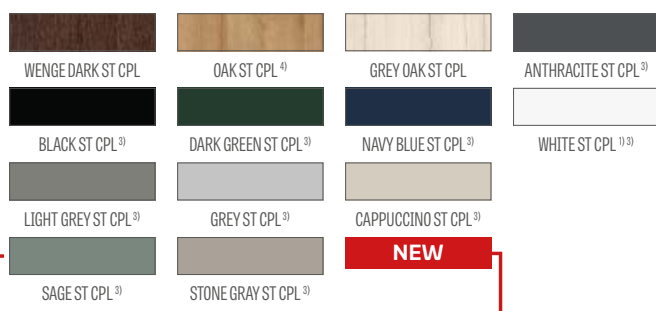

Glulam stiles⁴⁾

ADDITIONAL CHARGES

factory pre-drilled through holes for handles (split handles) ordered together with the door leaf

enhanced airflow trim standard or mini, ventilation undercut standard or mini (p. 149)

plastic woodgrain sleeves (4 pcs)

round and square metal sleeves (4 pcs); brushed nickel or patina finish in white and black

ventilation grille (only for door leaf widths of 80, 90, 100)

"100" rebated and non-rebated door leaf

VSG 221 laminated safety glass, plain on both sides

metal hinge casings in rebated door leaf (colour: brushed nickel, patina, glossy chrome, glossy brass, white and black)

drop down seal²⁾

can be replaced with a black, white or golden magnetic lock for non-rebated door leaves

change to black lock, hinges and striker plate for rebated doors

can be changed to hinges and strike plate in black, white or gold for non-rebated door leaves

magnetic stop (buffer)²⁾ (available in six colours p. 149) (while supplies last)

glulam stiles⁴⁾

¹⁾ plain white facing imitating a painted surface

²⁾ the use of a magnetic door stop makes it impossible to use a drop down seal and a ventilation undercut, and vice versa

³⁾ special **AntiFinger** coating to reduce dirt and fingerprints

⁴⁾ glulam stiles covered with HDF and MDF boards available for WHITE PREMIUM, NATUR OAK PREMIUM, GRAPHITE ASH PREMIUM, GREY MAPLE PREMIUM, OAK ST CPL for an additional charge

⁵⁾ only for non-rebated door leaves



DEBECJA

REBATED AND NON-REBATED INTERIOR STILE DOORS



DEBECJA 1 with CAPPUCCINO ST CPL facing layer with BELLA SLIM round glossy brass handle



DEBECJA 1



DEBECJA 2



DEBECJA 3



DEBECJA 4



DEBECJA 5



DEBECJA 6



DEBECJA 7

DEBECJA 7 with CAPPUCCINO ST CPL facing layer with BELLA SLIM round glossy/brass handle



DESIGN

- rebated or non-rebated door leaf made in the STILE panelled technology
- vertical and horizontal stiles made of MDF covered with GREKO, PREMIUM, ST CPL facings or ST CPL laminate with the AntiFinger coating
- glued laminated stiles covered with HDF and MDF boards⁴⁾
- 4 mm thick HDF panels with GREKO, CPL or PREMIUM finish
- very wide crossbar
- optional door frame extension panels and a crosshead with pilasters are available for an additional charge, pp. 151-153
- the door can be trimmed by a customer; go to p. 149 for details

HARDWARE

- rebated door leaves: three silver 2-pin hinges adjusted horizontally
- two (third for an additional charge) concealed hinges in a non-rebated door leaf, painted in silver (optionally black, white or gold – for an additional charge); hinges supplied with and included in the price of the door frame
- latch and pin lock in a rebated door leaf and a key-locked magnetic lock (latch and pin lock as an option) in a non-rebated door leaf, thumb turn cylinder, economy, with a silver blockade; optionally, for an additional charge, a black, white or gold magnetic lock

GLAZING

- tempered 4 mm glass, frosted or clear as a standard and, for an additional charge, laminated VSG 221 safety glass frosted or black plain on both sides
- possibility to change the glazing side to REVERSE (standard glazing for OBVERSE)

AVAILABLE SOLUTIONS (pp. 154-165)

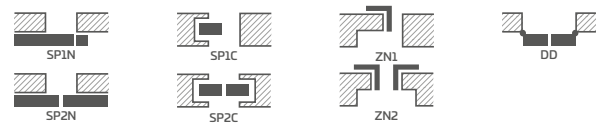

AVAILABLE DOOR LEAF WIDTHS



GREKO

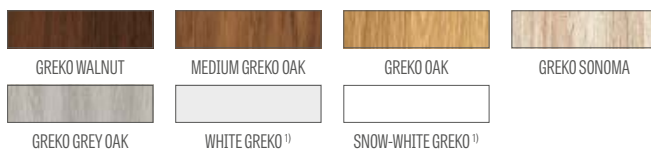

PREMIUM



CPL

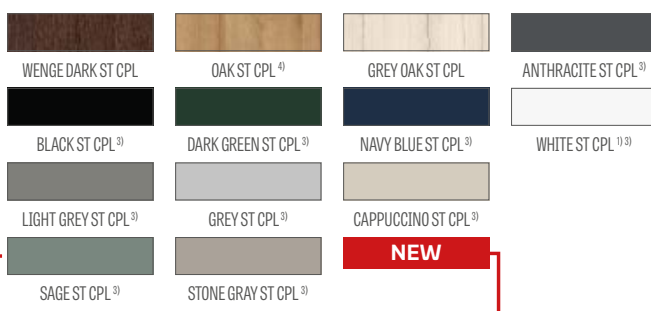

Glulam stiles⁴⁾

ADDITIONAL CHARGES

factory pre-drilled through holes for handles (split handles) ordered together with the door leaf

enhanced airflow trim standard or mini, ventilation undercut standard or mini (p. 149)

plastic woodgrain sleeves (4 pcs)

round and square metal sleeves (4 pcs); brushed nickel or patina finish in white and black

ventilation grille (only for door leaf widths of 80, 90, 100)

"100" rebated and non-rebated door leaf

VSG 221 laminated safety glass, plain on both sides

metal hinge casings in rebated door leaf (colour: brushed nickel, patina, glossy chrome, glossy brass, white and black)

drop down seal²⁾

can be replaced with a black, white or golden magnetic lock for non-rebated door leaves

change to black lock, hinges and striker plate for rebated doors

can be changed to hinges and strike plate in black, white or gold for non-rebated door leaves

magnetic stop (buffer)²⁾ (available in six colours p. 149) (while supplies last)

glulam stiles⁴⁾

¹⁾ plain white facing imitating a painted surface

²⁾ the use of a magnetic door stop makes it impossible to use a drop down seal and a ventilation undercut, and vice versa

³⁾ special **AntiFinger** coating to reduce dirt and fingerprints

⁴⁾ glulam stiles covered with HDF and MDF boards available for WHITE PREMIUM, NATUR OAK PREMIUM, GRAPHITE ASH PREMIUM, GREY MAPLE PREMIUM, OAK ST CPL for an additional charge

⁵⁾ only for non-rebated door leaves



SURMIA

REBATED AND NON-REBATED INTERIOR STILE DOORS



SURMIA 1 with WENGE DARK ST CPL facing layer with CUBE brushed matte chrome handle



SURMIA 1



SURMIA 2



SURMIA 3



SURMIA 4

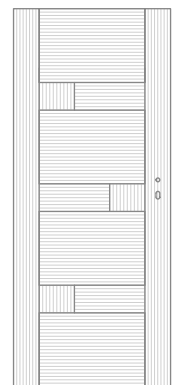

GRAIN PATTERN¹⁾

SURMIA 4 with WENGE DARK ST CPL facing layer with CUBE brushed matte chrome handle



DESIGN

- rebated or non-rebated door leaf made in the STILE panelled technology
- MDF stiles and rails covered with the PREMIUM, ST CPL facings or ST CPL laminate with the AntiFinger coating
- glued laminated stiles covered with HDF and MDF boards⁴⁾
- 22 mm and 4 mm thick HDF panels with CPL or PREMIUM finish
- 35 mm thick, very wide crossbar
- optional door frame extension panels and a crosshead with pilasters are available for an additional charge, pp. 151-153
- the door can be trimmed by a customer; go to p. 149 for details

HARDWARE

- rebated door leaves: three silver 2-pin hinges adjusted horizontally
- two (third for an additional charge) concealed hinges in a non-rebated door leaf, painted in silver (optionally black, white or gold – for an additional charge); hinges supplied with and included in the price of the door frame
- latch and pin lock in a rebated door leaf and a key-locked magnetic lock (latch and pin lock as an option) in a non-rebated door leaf, thumb turn cylinder, economy, with a silver blockade; optionally, for an additional charge, a black, white or gold magnetic lock

GLAZING

- tempered 4 mm glass, frosted or clear as a standard and, for an additional charge, laminated VSG 221 safety glass frosted or black plain on both sides
- possibility to change the glazing side to REVERSE (standard glazing for OBVERSE)

AVAILABLE SOLUTIONS (pp. 154-165)

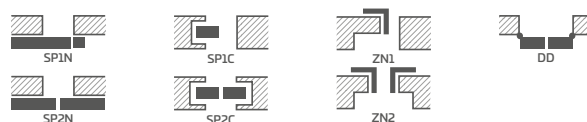

AVAILABLE DOOR LEAF WIDTHS



PREMIUM



CPL

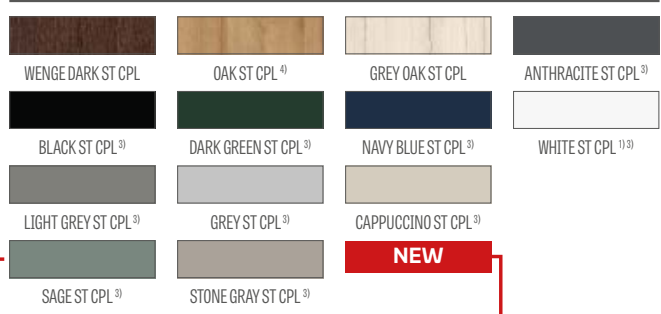

Glulam stiles⁴⁾

ADDITIONAL CHARGES

factory pre-drilled through holes for handles (split handles) ordered together with the door leaf

enhanced airflow trim standard or mini, ventilation undercut standard or mini (p. 149)

plastic woodgrain sleeves (4 pcs)

round and square metal sleeves (4 pcs); brushed nickel or patina finish in white and black

ventilation grille (only for door leaf widths of 80, 90, 100)

"100" rebated and non-rebated door leaf

VSG 221 laminated safety glass, plain on both sides

metal hinge casings in rebated door leaf (colour: brushed nickel, patina, glossy chrome, glossy brass, white and black)

drop down seal²⁾

can be replaced with a black, white or golden magnetic lock for non-rebated door leaves

change to black lock, hinges and striker plate for rebated doors

can be changed to hinges and strike plate in black, white or gold for non-rebated door leaves

magnetic stop (buffer)²⁾

(available in six colours p. 149) (while supplies last)

glulam stiles⁴⁾

¹⁾ plain white facing imitating a painted surface

²⁾ the use of a magnetic door stop makes it impossible to use a drop down seal and a ventilation undercut, and vice versa

³⁾ special **AntiFinger** coating to reduce dirt and fingerprints

⁴⁾ glulam stiles covered with HDF and MDF boards available for WHITE PREMIUM, NATUR OAK PREMIUM, GRAPHITE ASH PREMIUM, GREY MAPLE PREMIUM, OAK ST CPL for an additional charge

⁵⁾ only for non-rebated door leaves



BERBERYS, FLOKS

REBATED AND NON-REBATED INTERIOR STILE DOORS



BERBERYS 1 with WALNUT PREMIUM facing layer with CUBE brushed matte chrome handle



BERBERYS 1



BERBERYS 3



BERBERYS 5



BERBERYS 8



FLOKS 1



FLOKS 4



FLOKS 5



FLOKS 6

BERBERYS 1 with WALNUT PREMIUM facing layer with CUBE brushed matte chrome handle



DESIGN

- rebated or non-rebated door leaf made in the STILE panelled technology
- vertical and horizontal stiles made of MDF covered with GREKO, PREMIUM, ST CPL facings or ST CPL laminate with the AntiFinger coating
- glued laminated stiles covered with HDF and MDF boards⁴⁾
- 4 mm thick HDF panels with GREKO, CPL or PREMIUM finish
- brushed aluminium insert profiles
- optional door frame extension panels and a crosshead with pilasters are available for an additional charge, pp. 151-153
- the door can be trimmed by a customer; go to p. 149 for details

HARDWARE

- rebated door leaves: three silver 2-pin hinges adjusted horizontally
- two (third for an additional charge) concealed hinges in a non-rebated door leaf, painted in silver (optionally black, white or gold – for an additional charge); hinges supplied with and included in the price of the door frame
- latch and pin lock in a rebated door leaf and a key-locked magnetic lock (latch and pin lock as an option) in a non-rebated door leaf, thumb turn cylinder, economy, with a silver blockade; optionally, for an additional charge, a black, white or gold magnetic lock

GLAZING

- tempered 4 mm glass, frosted or clear as a standard and, for an additional charge, laminated VSG 221 safety glass frosted or black plain on both sides
- possibility to change the glazing side to REVERSE (standard glazing for OBERSE)

AVAILABLE SOLUTIONS (pp. 154-165)

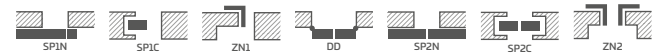

GREKO



PREMIUM



CPL

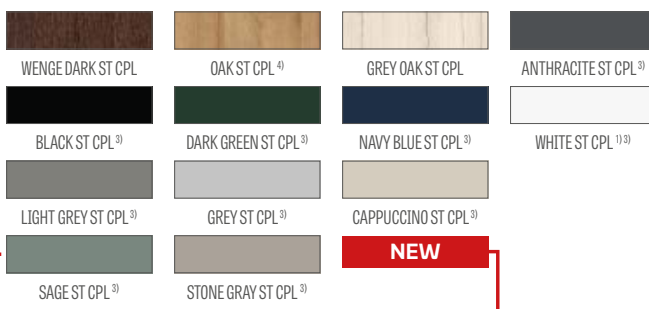

AVAILABLE DOOR LEAF WIDTHS



ADDITIONAL CHARGES

factory pre-drilled through holes for handles (split handles) ordered together with the door leaf

enhanced airflow trim standard or mini, ventilation undercut standard or mini (p. 149)

plastic woodgrain sleeves (4 pcs)

round and square metal sleeves (4 pcs); brushed nickel or patina finish in white and black

ventilation grille (only for door leaf widths of 80, 90, 100)

"100" rebated and non-rebated door leaf

VSG 221 laminated safety glass, plain on both sides

metal hinge casings in rebated door leaf

(colour: brushed nickel, patina, glossy chrome, glossy brass, white and black)

drop down seal²⁾

can be replaced with a black, white or golden magnetic lock for non-rebated door leaves

change to black lock, hinges and striker plate for rebated doors

can be changed to hinges and strike plate in black, white or gold for non-rebated door leaves

magnetic stop (buffer)²⁾

(available in six colours p. 149) (while supplies last)

glulam stiles⁴⁾

¹⁾ plain white facing imitating a painted surface

²⁾ the use of a magnetic door stop makes it impossible to use a drop down seal and a ventilation undercut, and vice versa

³⁾ special **AntiFinger** coating to reduce dirt and fingerprints

⁴⁾ glulam stiles covered with HDF and MDF boards available for WHITE PREMIUM, NATUR OAK PREMIUM, GRAPHITE ASH PREMIUM, GREY MAPLE PREMIUM, OAK ST CPL for an additional charge

⁵⁾ only for non-rebated door leaves



KROKUS

REBATED AND NON-REBATED INTERIOR STILE DOORS



KROKUS 1 with BLACK ST CPL facing layer with CUBE PREMIUM brushed matte chrome handle



KROKUS 1



KROKUS 2



KROKUS 3



KROKUS 4



KROKUS 5



KROKUS 6

KROKUS-4 with BLACK ST CPL facing layer with CUBE PREMIUM brushed matte chrome handle



DESIGN

- rebated or non-rebated door leaf made in the STILE panelled technology
- vertical and horizontal stiles made of MDF covered with GREKO, PREMIUM, ST CPL facings or ST CPL laminate with the AntiFinger coating
- glued laminated stiles covered with HDF and MDF boards⁴⁾
- 4 mm thick HDF panels with GREKO, CPL or PREMIUM finish
- brushed aluminium insert profiles
- optional door frame extension panels and a crosshead with pilasters are available for an additional charge, pp. 151-153
- the door can be trimmed by a customer; go to p. 149 for details

HARDWARE

- rebated door leaves: three silver 2-pin hinges adjusted horizontally
- two (third for an additional charge) concealed hinges in a non-rebated door leaf, painted in silver (optionally black, white or gold – for an additional charge); hinges supplied with and included in the price of the door frame
- latch and pin lock in a rebated door leaf and a key-locked magnetic lock (latch and pin lock as an option) in a non-rebated door leaf, thumb turn cylinder, economy, with a silver blockade; optionally, for an additional charge, a black, white or gold magnetic lock

GLAZING

- tempered 4 mm glass, frosted or clear as a standard and, for an additional charge, laminated VSG 221 safety glass frosted or black plain on both sides
- possibility to change the glazing side to REVERSE (standard glazing for OBVERSE)

AVAILABLE SOLUTIONS (pp. 154-165)

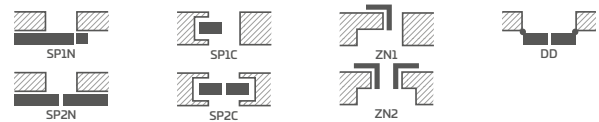

GREKO



PREMIUM



CPL

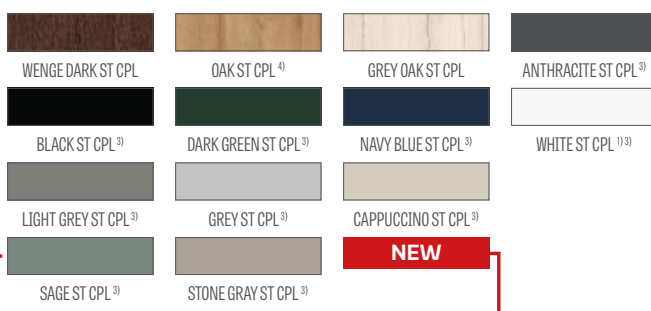

AVAILABLE DOOR LEAF WIDTHS



ADDITIONAL CHARGES

- factory pre-drilled through holes for handles (split handles) ordered together with the door leaf
- enhanced airflow trim standard or mini, ventilation undercut standard or mini (p. 149)
- plastic woodgrain sleeves (4 pcs)
- round and square metal sleeves (4 pcs); brushed nickel or patina finish in white and black
- ventilation grille (only for door leaf widths of 80, 90, 100)
- "100" rebated and non-rebated door leaf
- VSG 221 laminated safety glass, plain on both sides
- metal hinge casings in rebated door leaf (colour: brushed nickel, patina, glossy chrome, glossy brass, white and black)
- drop down seal²⁾
- can be replaced with a black, white or golden magnetic lock for non-rebated door leaves
- can be changed to hinges and strike plate in black, white or gold for non-rebated door leaves
- change to black lock, hinges and striker plate for rebated doors
- magnetic stop (buffer)²⁾ (available in six colours p. 149) (while supplies last)
- glulam stiles⁴⁾

¹⁾ plain white facing imitating a painted surface

²⁾ the use of a magnetic door stop makes it impossible to use a drop down seal and a ventilation undercut, and vice versa

³⁾ special **AntiFinger** coating to reduce dirt and fingerprints

⁴⁾ glulam stiles covered with HDF and MDF boards available for WHITE PREMIUM, NATUR OAK PREMIUM, GRAPHITE ASH PREMIUM, GREY MAPLE PREMIUM, OAK ST CPL for an additional charge

⁵⁾ only for non-rebated door leaves



KAMELIA

REBATED AND NON-REBATED INTERIOR STILE DOORS



KAMELIA 1 with GRAPHITE ASH PREMIUM facing layer, with CUBE brushed matte chrome handle



KAMELIA 1



KAMELIA 2



KAMELIA 3



KAMELIA 4



KAMELIA 5



KAMELIA 6



KAMELIA 7



KAMELIA 8

KAMELIA 1 with GRAPHITE ASH PREMIUM facing layer, with CUBE brushed matte chrome handle



DESIGN

- rebated or non-rebated door leaf made in the STILE panelled technology
- vertical and horizontal stiles made of MDF covered with GREKO, PREMIUM, ST CPL facings or ST CPL laminate with the AntiFinger coating
- glued laminated stiles covered with HDF and MDF boards⁴⁾
- 4 mm thick HDF panels with GREKO, CPL or PREMIUM finish
- optional door frame extension panels and a crosshead with pilasters are available for an additional charge, pp. 151-153
- the door can be trimmed by a customer, go to p. 149 for details

HARDWARE

- rebated door leaves: three silver 2-pin hinges adjusted horizontally
- two (third for an additional charge) concealed hinges in a non-rebated door leaf, painted in silver (optionally black, white or gold – for an additional charge); hinges supplied with and included in the price of the door frame
- latch and pin lock in a rebated door leaf and a key-locked magnetic lock (latch and pin lock as an option) in a non-rebated door leaf, thumb turn cylinder, economy, with a silver blockade; optionally, for an additional charge, a black, white or gold magnetic lock

GLAZING

- 4 mm glass, frosted or clear as a standard and, for an additional charge, laminated VSG 221 safety glass frosted or black plain on both sides
- possibility to change the glazing side to REVERSE (standard glazing for OBVERSE)

AVAILABLE SOLUTIONS (pp. 154-165)

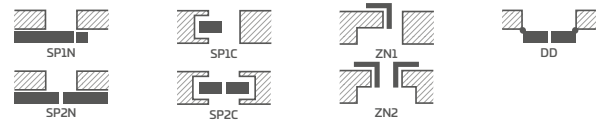

GREKO



PREMIUM

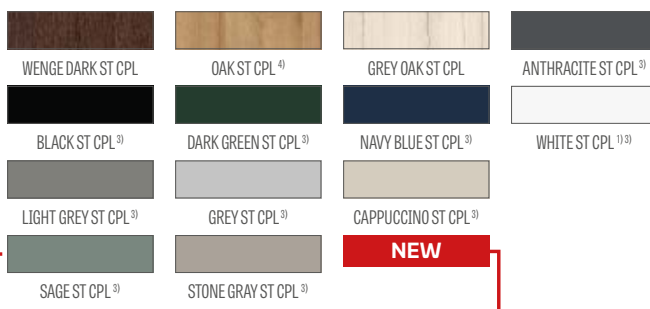

AVAILABLE DOOR LEAF WIDTHS



ADDITIONAL CHARGES

factory pre-drilled through holes for handles (split handles) ordered together with the door leaf

enhanced airflow trim standard or mini, ventilation undercut standard or mini (p. 149)

plastic woodgrain sleeves (4 pcs)

round and square metal sleeves (4 pcs); brushed nickel or patina finish in white and black

ventilation grille (only for door leaf widths of 80, 90, 100)

"100" rebated and non-rebated door leaf

VSG 221 laminated safety glass, plain on both sides

metal hinge casings in rebated door leaf (colour: brushed nickel, patina, glossy chrome, glossy brass, white and black)

drop down seal²⁾

can be replaced with a black, white or golden magnetic lock for non-rebated door leaves

change to black lock, hinges and striker plate for rebated doors

can be changed to hinges and strike plate in black, white or gold for non-rebated door leaves

magnetic stop (buffer)²⁾ (available in six colours p. 149) (while supplies last)

glulam stiles⁴⁾

¹⁾ plain white facing imitating a painted surface

²⁾ the use of a magnetic door stop makes it impossible to use a drop down seal and a ventilation undercut, and vice versa

³⁾ special **AntiFinger** coating to reduce dirt and fingerprints

⁴⁾ glulam stiles covered with HDF and MDF boards available for WHITE PREMIUM, NATUR OAK PREMIUM, GRAPHITE ASH PREMIUM, GREY MAPLE PREMIUM, OAK ST CPL for an additional charge

⁵⁾ only for non-rebated door leaves



PETUNIA

REBATED AND NON-REBATED INTERIOR STILE DOORS



PETUNIA 1 with OAK PREMIUM facing layer, with CUBE black matte handle



PETUNIA 1



PETUNIA 2



PETUNIA 3



PETUNIA 4



PETUNIA 5



PETUNIA 6



PETUNIA 7



PETUNIA 8

PETUNIA 6 with OAK PREMIUM facing layer and TOPAZ stainless steel handle



DESIGN

- rebated or non-rebated door leaf made in the STILE panelled technology
- vertical and horizontal stiles made of MDF covered with GREKO, PREMIUM, ST CPL facings or ST CPL laminate with the AntiFinger coating
- glued laminated stiles covered with HDF and MDF boards⁴⁾
- 4 mm thick HDF panels with GREKO, CPL or PREMIUM finish
- optional door frame extension panels and a crosshead with pilasters are available for an additional charge, pp. 151-153
- the door can be trimmed by a customer, go to p. 149 for details

HARDWARE

- rebated door leaves: three silver 2-pin hinges adjusted horizontally
- two (third for an additional charge) concealed hinges in a non-rebated door leaf, painted in silver (optionally black, white or gold – for an additional charge); hinges supplied with and included in the price of the door frame
- latch and pin lock in a rebated door leaf and a key-locked magnetic lock (latch and pin lock as an option) in a non-rebated door leaf, thumb turn cylinder, economy, with a silver blockade; optionally, for an additional charge, a black, white or gold magnetic lock

GLAZING

- tempered 4 mm glass, frosted or clear as a standard and, for an additional charge, laminated VSG 221 safety glass frosted or black plain on both sides
- possibility to change the glazing side to REVERSE (standard glazing for OBVERSE)

AVAILABLE SOLUTIONS (pp. 154-165)

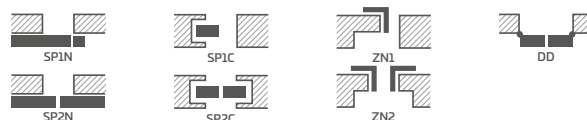

GREKO



PREMIUM



CPL

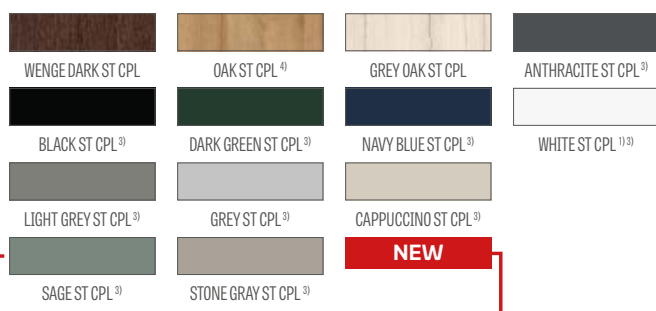

Glulam stiles⁴⁾

AVAILABLE DOOR LEAF WIDTHS



ADDITIONAL CHARGES

factory pre-drilled through holes for handles (split handles) ordered together with the door leaf

enhanced airflow trim standard or mini, ventilation undercut standard or mini (p. 149)

plastic woodgrain sleeves (4 pcs)

round and square metal sleeves (4 pcs); brushed nickel or patina finish in white and black

ventilation grille (only for door leaf widths of 80, 90, 100)

"100" rebated and non-rebated door leaf

VSG 221 laminated safety glass, plain on both sides

metal hinge casings in rebated door leaf (colour: brushed nickel, patina, glossy chrome, glossy brass, white and black)

drop down seal²⁾

can be replaced with a black, white or golden magnetic lock for non-rebated door leaves

change to black lock, hinges and striker plate for rebated doors

can be changed to hinges and strike plate in black, white or gold for non-rebated door leaves

magnetic stop (buffer)²⁾ (available in six colours p. 149) (while supplies last)

glulam stiles⁴⁾

¹⁾ plain white facing imitating a painted surface

²⁾ the use of a magnetic door stop makes it impossible to use a drop down seal and a ventilation undercut, and vice versa

³⁾ special **AntiFinger** coating to reduce dirt and fingerprints

⁴⁾ glulam stiles covered with HDF and MDF boards available for WHITE PREMIUM, NATUR OAK PREMIUM, GRAPHITE ASH PREMIUM, GREY MAPLE PREMIUM, OAK ST CPL for an additional charge

⁵⁾ only for non-rebated door leaves



AZALIA

REBATED AND NON-REBATED INTERIOR STILE DOORS



AZALIA 1 with DARK GREEN ST CPL facing layer with CUBE black matte handle



AZALIA 1



AZALIA 2



AZALIA 3



AZALIA 4



AZALIA 5



AZALIA 6



AZALIA 7



AZALIA 8

AZALIA 6 with DARK GREEN ST CPL facing layer with CUBE black matte handle



DESIGN

- rebated or non-rebated door leaf made in the STILE panelled technology
- vertical and horizontal stiles made of MDF covered with GREKO, PREMIUM, ST CPL facings or ST CPL laminate with the AntiFinger coating
- glued laminated stiles covered with HDF and MDF boards⁴⁾
- 4 mm thick HDF panels with GREKO, CPL or PREMIUM finish
- optional door frame extension panels and a crosshead with pilasters are available for an additional charge, pp. 151-153
- the door can be trimmed by a customer, go to p. 149 for details

HARDWARE

- rebated door leaves: three silver 2-pin hinges adjusted horizontally
- two (third for an additional charge) concealed hinges in a non-rebated door leaf, painted in silver (optionally black, white or gold – for an additional charge); hinges supplied with and included in the price of the door frame
- latch and pin lock in a rebated door leaf and a key-locked magnetic lock (latch and pin lock as an option) in a non-rebated door leaf, thumb turn cylinder, economy, with a silver blockade; optionally, for an additional charge, a black, white or gold magnetic lock

GLAZING

- tempered 4 mm glass, frosted or clear as a standard and, for an additional charge, laminated VSG 221 safety glass frosted or black plain on both sides
- possibility to change the glazing side to REVERSE (standard glazing for OBTVERSE)

AVAILABLE SOLUTIONS (pp. 154-165)

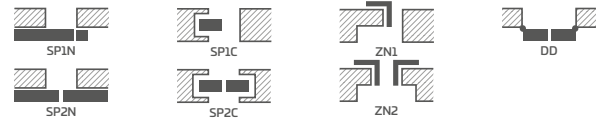

GREKO



PREMIUM

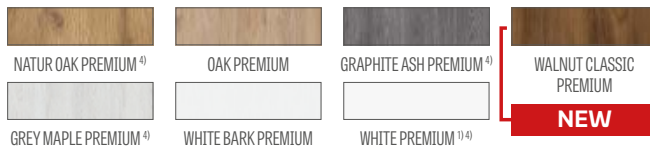

CPL

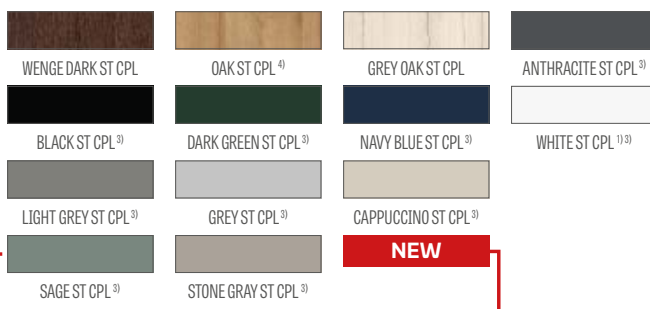

Glulam stiles⁴⁾

AVAILABLE DOOR LEAF WIDTHS



ADDITIONAL CHARGES

- factory pre-drilled through holes for handles (split handles) ordered together with the door leaf
- enhanced airflow trim standard or mini, ventilation undercut standard or mini (p. 149)
- plastic woodgrain sleeves (4 pcs)
- round and square metal sleeves (4 pcs); brushed nickel or patina finish in white and black
- ventilation grille (only for door leaf widths of 80, 90, 100)
- "100" rebated and non-rebated door leaf
- VSG 221 laminated safety glass, plain on both sides
- metal hinge casings in rebated door leaf (colour: brushed nickel, patina, glossy chrome, glossy brass, white and black)
- drop down seal²⁾
- can be replaced with a black, white or golden magnetic lock for non-rebated door leaves
- change to black lock, hinges and striker plate for rebated doors
- can be changed to hinges and strike plate in black, white or gold for non-rebated door leaves
- magnetic stop (buffer)²⁾ (available in six colours p. 149) (while supplies last)
- glulam stiles⁴⁾

¹⁾ plain white facing imitating a painted surface

²⁾ the use of a magnetic door stop makes it impossible to use a drop down seal and a ventilation undercut, and vice versa

³⁾ special **AntiFinger** coating to reduce dirt and fingerprints

⁴⁾ glulam stiles covered with HDF and MDF boards available for WHITE PREMIUM, NATUR OAK PREMIUM, GRAPHITE ASH PREMIUM, GREY MAPLE PREMIUM, OAK ST CPL for an additional charge

⁵⁾ only for non-rebated door leaves



HIACYNT

REBATED AND NON-REBATED INTERIOR STILE DOORS



HIACYNT 6 with MAPLE GREY PREMIUM facing layer, with QUANTA FIT black matte handle



HIACYNT 1



HIACYNT 2



HIACYNT 3



HIACYNT 4



HIACYNT 5



HIACYNT 6



HIACYNT 7



HIACYNT 8

HIACYNT 1 with MAPLE GREY PREMIUM facing layer, with QUANTA FIT black matte handle



DESIGN

- rebated or non-rebated door leaf made in the STILE panelled technology
- vertical and horizontal stiles made of MDF covered with GREKO, PREMIUM, ST CPL facings or ST CPL laminate with the AntiFinger coating
- glued laminated stiles covered with HDF and MDF boards⁴⁾
- 22 mm thick HDF panels with GREKO, CPL or PREMIUM finish
- optional door frame extension panels and a crosshead with pilasters are available for an additional charge, pp. 151-153
- the door can be trimmed by a customer, go to p. 149 for details

HARDWARE

- rebated door leaves: three silver 2-pin hinges adjusted horizontally
- two (third for an additional charge) concealed hinges in a non-rebated door leaf, painted in silver (optionally black, white or gold – for an additional charge); hinges supplied with and included in the price of the door frame
- latch and pin lock in a rebated door leaf and a key-locked magnetic lock (latch and pin lock as an option) in a non-rebated door leaf, thumb turn cylinder, economy, with a silver blockade; optionally, for an additional charge, a black, white or gold magnetic lock

GLAZING

- tempered 4 mm glass, frosted or clear as a standard and, for an additional charge, laminated VSG 221 safety glass frosted or black plain on both sides
- possibility to change the glazing side to REVERSE (standard glazing for OBVERSE)

AVAILABLE SOLUTIONS (pp. 154-165)



AVAILABLE DOOR LEAF WIDTHS



GREKO



PREMIUM



CPL

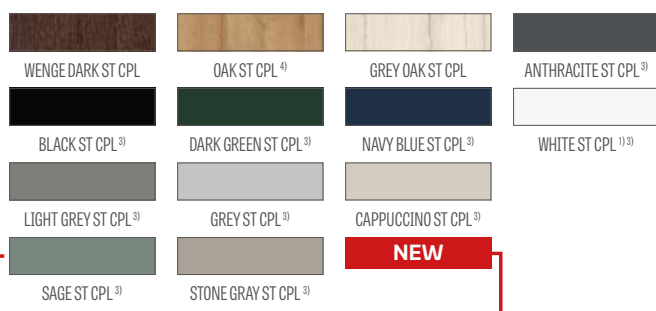

Glulam stiles⁴⁾

ADDITIONAL CHARGES

factory pre-drilled through holes for handles (split handles) ordered together with the door leaf

enhanced airflow trim standard or mini, ventilation undercut standard or mini (p. 149)

plastic woodgrain sleeves (4 pcs)

round and square metal sleeves (4 pcs); brushed nickel or patina finish in white and black

ventilation grille (only for door leaf widths of 80, 90, 100)

"100" rebated and non-rebated door leaf

VSG 221 laminated safety glass, plain on both sides

metal hinge casings in the rebated door leaf (brushed nickel, patina, polished chrome, polished brass, white and black)

drop down seal²⁾

can be replaced with a black, white or golden magnetic lock for non-rebated door leaves

change to black lock, hinges and striker plate for rebated doors

can be changed to hinges and strike plate in black, white or gold for non-rebated door leaves

magnetic stop (buffer)²⁾
(available in six colours p. 149) (while supplies last)

glulam stiles⁴⁾

¹⁾ plain white facing imitating a painted surface

²⁾ the use of a magnetic door stop makes it impossible to use a drop down seal and a ventilation undercut, and vice versa

³⁾ special **AntiFinger** coating to reduce dirt and fingerprints

⁴⁾ glulam stiles covered with HDF and MDF boards available for WHITE PREMIUM, NATUR OAK PREMIUM, GRAPHITE ASH PREMIUM, GREY MAPLE PREMIUM, OAK ST CPL for an additional charge

⁵⁾ only for non-rebated door leaves



FRAGI

REBATED INTERIOR STILE DOORS



FRAGI 19 POINT **NEW** with BLACK ST CPL facing layer; with CUBE PREMIUM brushed matte chrome handle



FRAGI 4
DECORMAT



FRAGI 5
CLEAR



FRAGI 7
DECORMAT GRAFIT



FRAGI 9



FRAGI 10



FRAGI 15
Frosted VSG/ESG



FRAGI 16
Black VSG/ESG



FRAGI 17
SMOKED GRAPHITE

FRAGI 18 RELIEF with BLACK ST CPL facing layer with CUBE PREMIUM brushed matte chrome handle



NEW

DESIGN

- rebated or non rebated door leaf **NEW** (except FRAGI 9 and 10) made using STILE technology
- vertical and horizontal stiles made of MDF covered with GREKO, PREMIUM, ST CPL or ST CPL laminate with AntiFinger coating
- glued laminated stiles covered with HDF and MDF boards³⁾
- in the case of a non-rebated door leaf, due to the glass being reversed at the top, the glass does not adhere to the gasket (the technology gap remains)
- optional door frame extension panels and a crosshead with pilasters are available for an additional charge, pp. 151-153

HARDWARE

- rebated door leaves: three silver 2-pin hinges adjusted horizontally
- two (third for an additional charge) concealed hinges in a non-rebated door leaf, painted in silver (optionally black, white or gold – for an additional charge); hinges supplied with and included in the price of the door frame
- latch and pin lock in a rebated door leaf and a key-locked magnetic lock (latch and pin lock as an option) in a non-rebated door leaf, thumb turn cylinder, economy, with a silver blockade; optionally, for an additional charge, a black, white or gold magnetic lock

GLAZING

- 8 mm tempered glass or tempered and laminated VSG/ESG 441 frosted glass or black safety glass, plain glass on both sides (models FRAGI 15 and FRAGI 16), plain mass-coloured (FRAGI 17) **NEW** or decorative tempered glass 8 mm relief (FRAGI 18) and point (FRAGI 19) **NEW**. Relief and point glass are smooth on one side.
- possibility to change the glazing side to REVERSE (standard glazing for OBVERSE)

AVAILABLE SOLUTIONS (pp. 151-153)



AVAILABLE DOOR LEAF WIDTHS

60 70 80N⁴⁾ 80 90

ADDITIONAL CHARGES

factory pre-drilled through holes for handles (split handles) ordered together with the door leaf

ventilation undercut

metal hinge casings in rebated door leaf

(colour: brushed nickel, patina, glossy chrome, glossy brass, white and black)

can be replaced with a black, white or golden magnetic lock for non-rebated door leaves

change to black lock, hinges and striker plate for rebated doors

can be changed to hinges and strike plate in black, white or gold for non-rebated door leaves

magnetic stop (buffer)

(available in six colours p. 149) (while supplies last)

glulam stiles³⁾

Note:

The picture shows only an 80cm-wide door leaf. The proportion in the picture differ slightly for the other FRAGI 1 model widths. For further details and photos go to our website:

www.erkado.pl

GREKO



PREMIUM



CPL

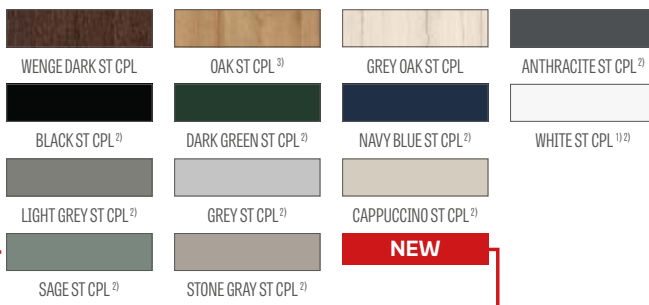

Glulam stiles³⁾

¹⁾ plain white facing imitating a painted surface

²⁾ special **AntiFinger** coating to reduce dirt and fingerprints

³⁾ glulam stiles covered with HDF and MDF boards available for WHITE PREMIUM, NATUR OAK PREMIUM, GRAPHITE ASH PREMIUM, GREY MAPLE PREMIUM, OAK ST CPL for an additional charge

⁴⁾ only for non-rebated door leaves

STANDARD "OBVERSE" GLAZING

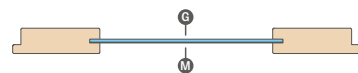

G – smooth side
M – matte side
with decor

"REVERSE" GLAZING MADE TO ORDER

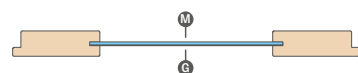

LOFT BASIC



LOFT BASIC 2 black, tempered clear glass, "90" door 2200 mm high, side light 500 mm wide, solid core height with top light 3000 mm



DESIGN

- doors made of steel profiles, glazed, with steel 20 mm wide and 2 mm thick muntins bonded to the glass on both sides
- leaf and side light frame made of steel profiles, powder-coated as standard in BLACK STR and WHITE STR colours, and for an additional charge in the RAL colours STR
- doors can be ordered in standard sizes (see table on page 66) with made-to-measure side lights in size range as from 200 mm in width and then every 3 mm up to 1000 mm and in height as from 1900 mm and then every 3 mm up to 2200 mm (see page 66 for side light options)
- minimum top light height is 200 mm and maximum 1000 mm; possibility to order made to measure size every 3 mm
- doors leaves can be made to measure as from 70 mm in width and then every 3 mm up to 100 mm and 1900 mm and then every 3mm up to 2200 mm in height (H&D variants only).
- when changing the dimensions of LOFT BASIC models, the arrangement of the muntins changes proportionally as the width and height increase
- maximum door height with a top light is 3000 mm, maximum width of a side light is 1000 mm
- powder-coated profiles; all colours have a fine STR texture which reduces dirt and fingerprints
- the arrangement of the muntin bars is variable depending on the dimensions (details in the B2B panel)
- cover angle (at extra charge) to be mounted on your own, dimensions 15 x 15 x 1.5 mm and length 3 m, in standard colors and at extra charge in RAL

HARDWARE

- three welded steel hinges
- magnetic catch
- DIVA FIT handle or pull handle as standard

GLAZING

- tempered transparent glass 6 mm as standard
- for an additional charge, VSG frosted glass 6 mm, dark grey 6 mm, smoky graphite 6 mm, decorative relief glass 6 mm and point 8 mm; decorative glass is textured on one side (OBVERSE) and smooth on the other side (REVERSE); it is possible to change the glazing side to REVERSE (OBVERSE as standard).

AVAILABLE DOOR LEAF WIDTHS



SOLUTIONS AVAILABLE

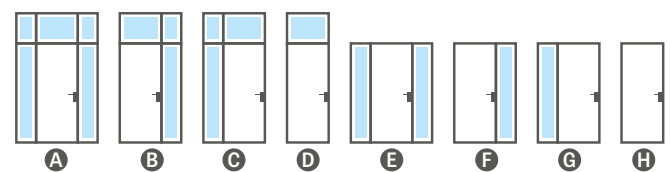

ADDITIONAL CHARGES

STR painted profiles in RAL colours 5002, 6005, 7006, 7016, 7024, 7032, 8017, 9007, 9010	+ 15%
smoked graphite glass 6 mm	
dark grey glass 6 mm	
relief glass 6 mm	
point glass 8 mm	
VSG frosted glass 6 mm	
door with BELLA SLIM black matte handle	
enhanced airflow trim 5 mm or 10 mm ¹⁾	
covering angle 15x15x1.5 mm, length 3 m; black str or white str	
insert (three keys) black or silver	

POWDER COATED²⁾



RAL STR (for an additional charge)



¹⁾ air gap under the entire leaf width is 9 mm as standard, with the enhanced airflow trim it will be 14 mm or 19 mm respectively

²⁾ a transom with an area of less than 0.7 m² – price as for a 0.7 m² transom

LOFT CLASSIC



LOFT CLASSIC 1 in black, tempered clear glass, door "90" height 2200 mm, side light 500 mm wide, solid core height with top light 3000 mm



DESIGN

- doors made of steel profiles, glazed, with steel 20 mm wide and 2 mm thick muntins bonded to the glass on both sides
- leaf and side light frame made of steel profiles, powder-coated as standard in BLACK STR and WHITE STR colours, and for an additional charge in the RAL colours STR
- doors can be ordered in standard sizes (see table on page 66) with made-to-measure side lights in size range as from 200 mm in width and then every 3 mm up to 1000 mm and in height as from 1900 mm and then every 3 mm up to 2200 mm (see page 66 for side light options)
- minimum top light height is 200 mm and maximum 1000 mm; possibility to order made to measure size every 3 mm
- doors leaves can be made to measure as from 70 mm in width and then every 3 mm up to 100 mm and 1900 mm and then every 3mm up to 2200 mm in height (H&D variants only).
- when changing the dimensions of LOFT CLASSIC models, the arrangement of the muntins changes proportionally as the width and height increase
- maximum door height with a top light is 3000 mm, maximum width of a side light is 1000 mm
- powder-coated profiles; all colours have a fine STR texture which reduces dirt and fingerprints
- the arrangement of the muntin bars is variable depending on the dimensions (details in the B2B panel)
- cover angle (at extra charge) to be mounted on your own, dimensions 15 x 15 x 1.5 mm and length 3 m, in standard colors and at extra charge in RAL

HARDWARE

- three welded steel hinges
- magnetic catch
- DIVA FIT handle or pull handle as standard

GLAZING

- tempered transparent glass 6 mm as standard
- for an additional charge, VSG frosted glass 6 mm, dark grey 6 mm, smoky graphite 6 mm, decorative relief glass 6 mm and point 8 mm; decorative glass is textured on one side (OBVERSE) and smooth on the other side (REVERSE); it is possible to change the glazing side to REVERSE (OBVERSE as standard).

AVAILABLE DOOR LEAF WIDTHS



SOLUTIONS AVAILABLE

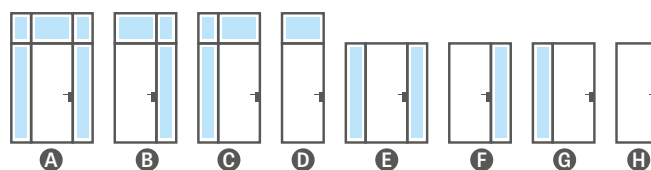

ADDITIONAL CHARGES

STR painted profiles in RAL colours 5002, 6005, 7006, 7016, 7024, 7032, 8017, 9007, 9010 + 15%

smoked graphite glass 6 mm

dark grey glass 6 mm

relief glass 6 mm

point glass 8 mm

VSG frosted glass 6 mm

door with BELLA SLIM black matte handle

enhanced airflow trim 5 mm or 10 mm¹⁾

covering angle 15x15x1.5 mm, length 3 m; black str or white str

insert (three keys) black or silver

POWDER COATED²⁾



RAL STR (for an additional charge)

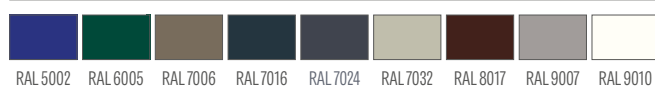

¹⁾ air gap under the entire leaf width is 9 mm as standard, with the enhanced airflow trim it will be 14 mm or 19 mm respectively

²⁾ a transom with an area of less than 0.7 m² – price as for a 0.7 m² transom

LOFT ART



LOFT ART 2 in black, tempered clear glass, door "90" height 2200 mm,
side light 500 mm wide, solid core height with top light 3000 mm



LOFT ART 1



LOFT ART 2

DESIGN

- doors made of steel profiles, glazed, with steel 20 mm wide and 2 mm thick muntins bonded to the glass on both sides
- leaf and side light frame made of steel profiles, powder-coated as standard in BLACK STR and WHITE STR colours, and for an additional charge in the RAL colours STR
- doors can be ordered in standard sizes (see table on page 66) with made-to-measure side lights in size range as from 200 mm in width and then every 3 mm up to 1000 mm and in height as from 1900 mm and then every 3 mm up to 2200 mm (see page 66 for side light options)
- minimum top light height is 200 mm and maximum 1000 mm; possibility to order made to measure size every 3 mm
- doors leaves can be made to measure as from 70 mm in width and then every 3 mm up to 100 mm and 1900 mm and then every 3mm up to 2200 mm in height (H&D variants only).
- when changing the dimensions of LOFT ART models, for height, the area between the muntin bars above the handle and the top one changes, for width, the area between the extreme vertical muntin bars changes
- maximum door height with a top light is 3000 mm, maximum width of a side light is 1000 mm
- powder-coated profiles; all colours have a fine STR texture which reduces dirt and fingerprints
- the arrangement of the muntin bars is variable depending on the dimensions (details in the B2B panel)
- cover angle (at extra charge) to be mounted on your own, dimensions 15 x 15 x 1.5 mm and length 3 m, in standard colors and at extra charge in RAL

HARDWARE

- three welded steel hinges
- magnetic catch
- DIVA FIT handle or pull handle as standard

GLAZING

- tempered transparent glass 6 mm as standard
- for an additional charge, VSG frosted glass 6 mm, dark grey 6 mm, smoky graphite 6 mm, decorative relief glass 6 mm and point 8 mm; decorative glass is textured on one side (OBERSE) and smooth on the other side (REVERSE); it is possible to change the glazing side to REVERSE (OBERSE as standard).

AVAILABLE DOOR LEAF WIDTHS



SOLUTIONS AVAILABLE

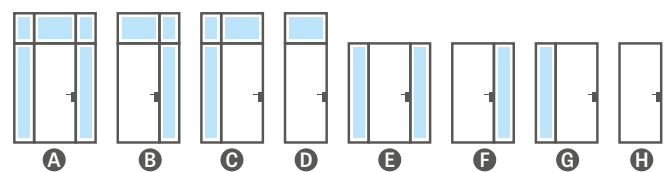

ADDITIONAL CHARGES

STR painted profiles in RAL colours 5002, 6005, 7006, 7016, 7024, 7032, 8017, 9007, 9010 + 15%

smoked graphite glass 6 mm

dark grey glass 6 mm

relief glass 6 mm

point glass 8 mm

VSG frosted glass 6 mm

door with BELLA SLIM black matte handle

enhanced airflow trim 5 mm or 10 mm¹⁾

covering angle 15x15x1.5 mm, length 3 m; black str or white str

insert (three keys) black or silver

POWDER COATED²⁾



RAL STR (for an additional charge)



¹⁾ air gap under the entire leaf width is 9 mm as standard, with the enhanced airflow trim it will be 14 mm or 19 mm respectively

²⁾ a transom with an area of less than 0.7 m² – price as for a 0.7 m² transom

DIMENSIONS OF STANDARD DOORS

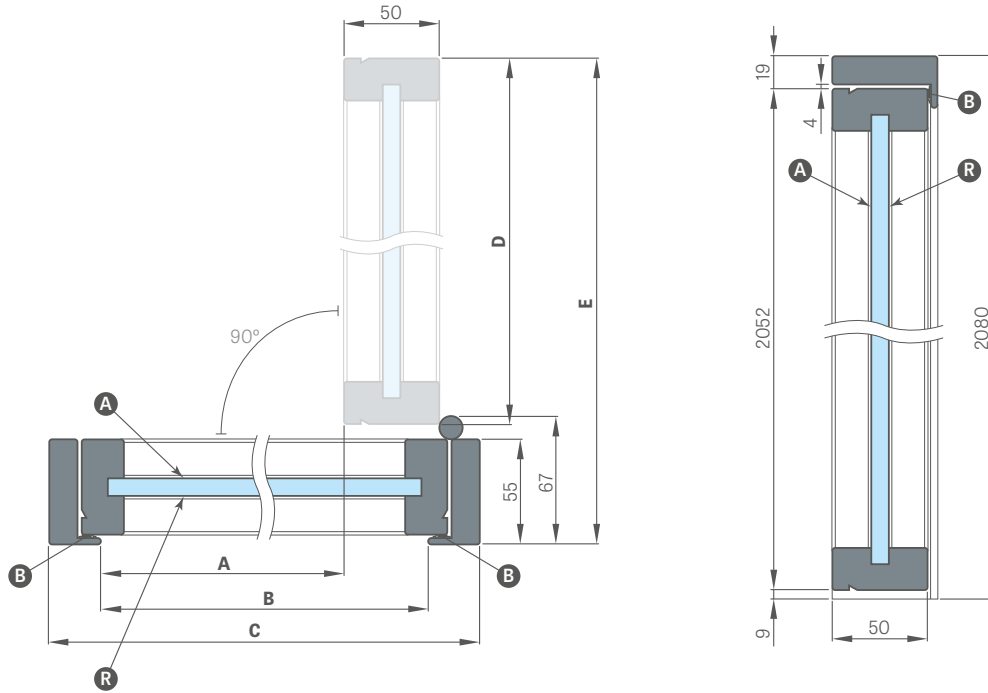

Door width	Clear opening	Frame opening	Frame width	Door leaf width	Opening range of door with frame
	A	B	C	D	E
70	702	746	800	762	826
80	802	846	900	862	926
90	902	946	1000	962	1026
100	1002	1046	1100	1062	1126

A - glazing, FRONT page
R - glazing, BACK page
B - rubber gasket

SOLUTIONS AVAILABLE

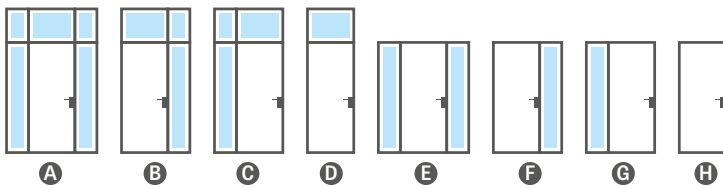

HANDLE AND GRIP



DIVA FIT handle
black matte square
(as standard)

BELLA SLIM handle
black matte square
(for an additional
change)

steel handle
painted
in the door colour

TYPES OF GLAZING AVAILABLE

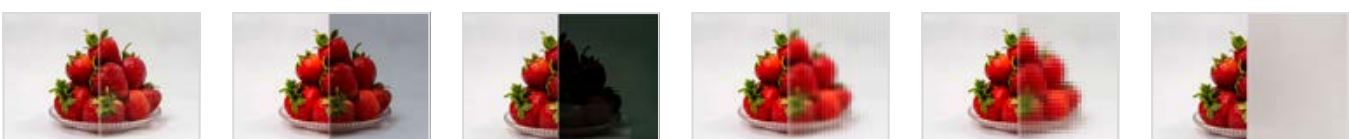

TRANSPARENT GLASS

SMOKED GRAPHITE

DARK GREY

RELIEF GLASS

POINT GLASS

FROSTED VSG

LOFT

INTERNAL STEEL DOOR LEAVES



LOFT ART 1 in black, tempered clear glass, door "90" height 2200 mm, side light 500 mm wide, solid core height with top light 3000 mm



GRAF GLASS DOORS

INTERIOR GLASS DOORS



GRAF 68 with decorative relief glazing, facing layer BLACK ST CPL

GRAF GLASS DOORS

INTERIOR GLASS DOORS



GRAF 35

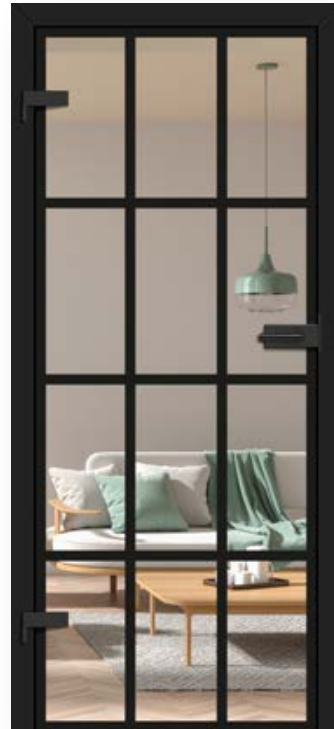

GRAF 36

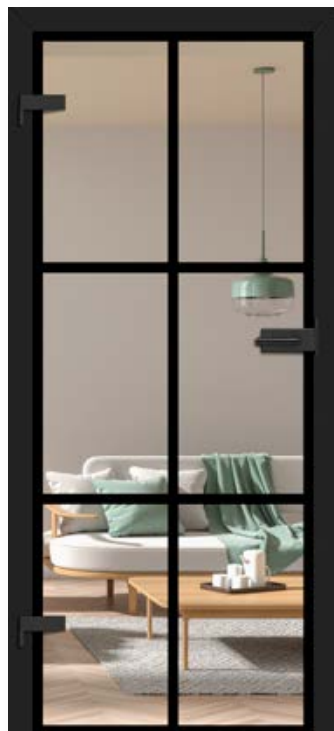

GRAF 61



GRAF 62

GLAZING TRANSLUCENCY REFERENCE PHOTOS in p. 150

GRAF GLASS DOORS

INTERIOR GLASS DOORS

NEW



GRAF 11 DECORMAT GRAPHITE



GRAF 67 SMOKED GRAPHITE



GRAF 8 DECORMAT



GRAF 9 CLEAR

NEW



GRAF 68 RELIEF

NEW

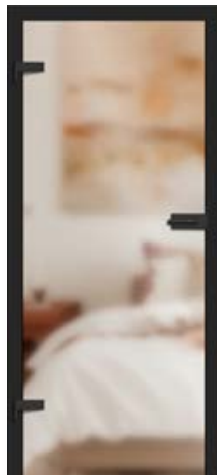

GRAF 69 POINT

NEW



GRAF 66 VSG/ESG frosted

NEW



GRAF 65 VSG/ESG, black opaque



GRAF 68
RELIEF glass



GRAF 69
POINT glass



GRAF 32



GRAF 33



GRAF 38



GRAF 39

GLAZING TRANSLUCENCY REFERENCE PHOTOS in p. 150

DESIGN

- 8 mm tempered glass with or without external decorative patterns, 8 mm Antisol tinted glass (GRAF 26 and 67 **NEW**), laminated and tempered VSG/ESG (GRAF 65, 66) glass or, for an additional charge, laminated and tempered VSG/ESG glass with black internal decorative patterns for GRAF 34, 37, 63, 33, 36, 61, 61 or white
- possibility to change the glazing side to REVERSE (standard glazing for OBVERSE)
- frosted or plain glass with black or white painted patterns, depending on the model design
- the line width (thickness) of the GRAF 35, 36, 38, 39, 61, 62 models is 30 mm
- optional door frame extension panels and a crosshead with pilasters are available for an additional charge, pp. 151-153
- available model GRAF 66, VSG/ESG frosted glass **NEW**
- models 33, 34, 36, 37, 39, 61, 63 available with smoked graphite glass
- GRAF 68 RELIEF **NEW** and GRAF 69 POINT models **NEW** 8 mm tempered decorative glass. Relief and point glass are smooth on one side.

FIXED AND ADJUSTABLE FRAMES

- for prices of fixed and adjustable frames for rebated doors go to pp. 180-183
- no electric strike possible
- 10 mm pin hinge for glass panes frames
- in the fixed and adjustable frame, it is possible to change the black or white powder-coated striker plate (for an additional charge)
- ONLY REBATED FRAMES IN ALL AVAILABLE FACINGS, STEEL FRAMES AND THE TITANIUM WHITE UV PAINTED FRAME ARE AVAILABLE FOR GLASS GRAF DOORS (NOT AVAILABLE FOR VERTICAL HINGE OPTION)**

NOTE: For the extended Glass Door Collection and a variety of available models go to our website: www.erkado.pl. You can also order the available models through the B2B panel.

ADDITIONAL CHARGES

VSG/ESG clear glass with internal application in black³⁾ (GRAF models 33, 36, 39, 61) or white (models 34, 67, 63)

smoked graphite glass (GRAF 33, 36, 39, 61 models)

rail-mounted door closer in silver, black

"90" door leaf

"100" and "110" door leaf²⁾ **NEW** (three hinges used as standard)

ventilation undercut

black or white striker plate

vertical hinges **NEW**

AVAILABLE DOOR LEAF WIDTHS

60 70 80 90, 100, 110 (for an additional charge)



See more at www.erkado.pl

METAL-BUD FITTINGS stainless steel, black, white (available shapes: oval or rectangle)

Metal-Bud



HARDWARE TYPE	TWO HINGES		THREE HINGES	
	stainless steel	Colours: black, white	stainless steel	Colours: black, white
1A OVAL SET (handle with economy lock + 10 mm pin hinges)				
2A OVAL SET (handle with key lock + 10 mm pin hinges)				
3A OVAL SET (handle with core lock + 10 mm pin hinges)				
4AZ OVAL EXTERNAL SET (handle + lock with thumbturn + 10 mm pin hinges) ¹⁾				
4AW OVAL INTERNAL SET (handle + lock with thumbturn + 10 mm pin hinges) ¹⁾				
1B SLIM RECTANGLE SET (handle with economy lock + 10 mm pin hinges)				
2B SLIM RECTANGLE SET (handle with key lock + 10 mm pin hinges)				
3B SLIM RECTANGLE SET (handle with euro profile lock + 10 mm pin hinges)				
4BZ SLIM RECTANGLE EXTERNAL SET (handle + lock with thumbturn + 10 mm pin hinges) ¹⁾				
4BW SLIM RECTANGLE INTERNAL SET (handle + lock with thumbturn + 10 mm pin hinges) ¹⁾				
31/17 euro profile cylinder				
euro profile cylinder with a thumbturn 31G/17 or 27/21G				

¹⁾ detailed description on selecting bathroom fittings (locking device) p. 148; ²⁾ available for GRAF 8, 9, 11, 65, 66 models; ³⁾ with VSG/ESG glass there are two glued glass panes visible from the edge



LAMELLAS

WALL-MOUNTED



Wall lamellas with oak ST CPL facing layer, with adapter with OAK ST CPL facing layer and skirting board with OAK ST CPL facing layer.
BALDUR 1 door with OAK ST CPL facing layer, with VSG black glazing

Decorative lamellas are mounted on the wall as a decorative element and at the same time improve the acoustics in the room.

Mounting is possible in several ways – the decorative skirting board can be mounted to the wall by means of a mounting strip only or with the use of adapters which constitute a base for the panels.

Decorative lamellas are available with PREMIUM and ST CPL facings and can be joined in selected combinations.



composition of decorative lamellas with the skirting board with OAK ST CPL facing layer



components of wall lamellas

DECORATIVE STRIP

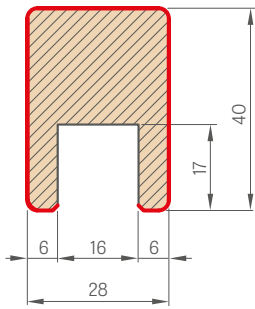

MOUNTING STRIP

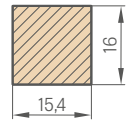

END STRIP

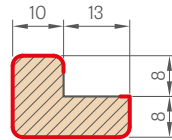

DECORATIVE LAMELLA

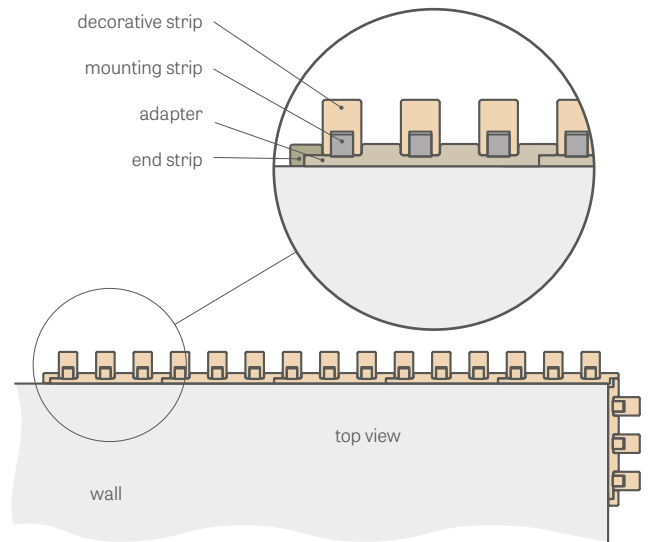

ADAPTER

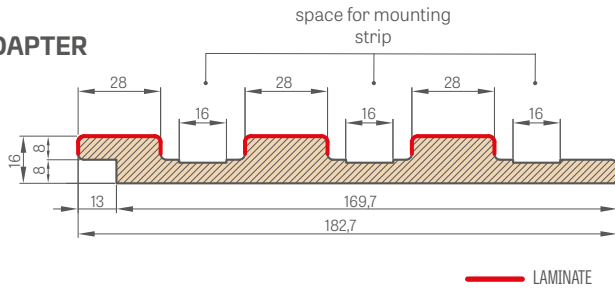

	ST CPL & PREMIUM
adapter, length 2750 mm	
decorative strip (mounting strip included), length 2750 mm	
end strip, length 2750 mm	
self-adhesive blanking straps for concealing the cut of a decorative strip	

The individual components of the decorative lamella system are commercially available in a length of 2750 mm, however each product has a production length of 2800 mm and is delivered in this length, where 25 mm per side is a margin for free trimming before installation and also a reserve in case of transport damage.

The wall lamellas can also be mounted without an adapter directly to the wall using only a mounting strip on which we mount the decorative strip.

Decorative strip (with the mounting strip included) can be purchased only in multiple of 3 pieces, e.g. 3 pcs, 6 pcs, 9 pcs, etc.

The blanking straps are available across the range of facings and are used to conceal the cut of the decorative strip. The blanking straps have a self-adhesive surface on one side.

adapter – quantity in pack 1 piece

end strip – package quantity 1 piece

decorative strip + mounting strip – pack of 3 pcs + 3 pcs

installation video
variant with an adapter:
<https://youtu.be/p3I7u3cWMmg>



installation video
no adapter variant:
<https://youtu.be/fFa5afWWFOM>



PREMIUM

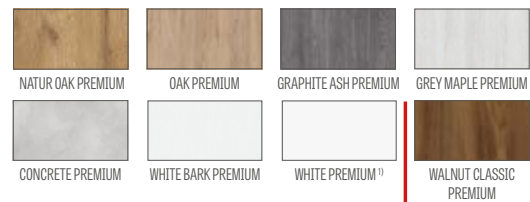

CPL

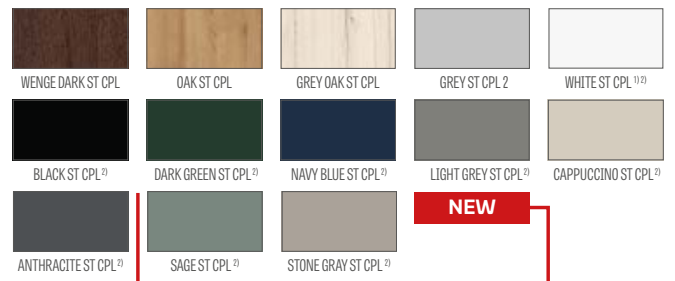

SKIRTING BOARDS

SKIRTING BOARD

- length: 2.40 running metres.
- laminated
- lacquered
- the skirting board is made of moisture resistant MDF board. Available variants: TITANIUM WHITE UV paint, laminates: GREKO, ST CPL, PREMIUM and in base laminate to be paint coated.
- fitting method: bonding to wall

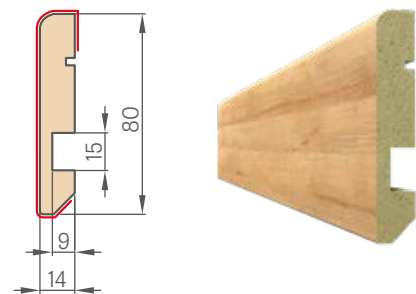

¹⁾ plain white facing imitating a painted surface

²⁾ special **AntiFinger** coating to reduce dirt and fingerprints



AMARYLIS

REBATED, NON-REBATED AND REVERSE PAINTED DOORS



AMARYLIS 1 with CUBE PREMIUM black matte handle



AMARYLIS 1



AMARYLIS 2



AMARYLIS 3



AMARYLIS 4



AMARYLIS 5



AMARYLIS 6



AMARYLIS 7



AMARYLIS 8



AMARYLIS 9



Double-sided stick-on muntin
25 mm

AMARYLIS 6 with CUBE PREMIUM black matte handle, with decorative relief glazing



DESIGN

- rebated, non-rebated or reverse door leaf in STILE technology for an additional charge
- MDF stiles and rails coated with a facing layer and painted with UV-resistant varnish
- optional, for an additional charge, glulam stiles covered with HDF and MDF boards
- double-sided muntin applied to glass, 25 mm wide and of respective heights: vertical 12 mm and horizontal 8 mm
- optional door frame extension panels and a crosshead with pilasters are available for an additional charge, pp. 151-153
- the door can be trimmed by a customer, go to p. 149 for details

FINISH

- door leaves and door frames coated with water-based UV hardened varnish for high resistance to adverse use conditions

HARDWARE

- rebated door leaves: three silver 2-pin hinges adjusted horizontally
- two (third for an additional charge) concealed hinges in a non-rebated door leaf, painted in silver (optionally black, white or gold – for an additional charge); hinges supplied with and included in the price of the door frame
- latch and pin lock in a rebated door leaf and a key-locked magnetic lock (latch and pin lock as an option) in a non-rebated door leaf, thumb turn cylinder, economy, with a silver blockade; optionally, for an additional charge, a black, white or gold magnetic lock

GLAZING

- tempered 4 mm glass, frosted or clear as a standard and, for an additional charge, laminated VSG 221 safety glass frosted or black plain on both sides, or decorative tempered glass 4 mm relief and point **NEW** (Relief and point glass are smooth on one side)
- possibility to change the glazing side to REVERSE (standard glazing for OBVERSE)

ADDITIONAL CHARGES

factory pre-drilled through holes for handles (split handles) ordered together with the door leaf

reverse door leaf

enhanced airflow trim standard or mini, ventilation undercut standard or mini (p. 149)

"100" rebated and non-rebated door leaf

metal hinge casings in the rebated door leaf (brushed nickel, patina, polished chrome, polished brass, white and black)

VSG 221 laminated safety glass, clear on both sides or decorative glass

drop down seal ¹⁾

can be replaced with a black, white or gold magnetic lock for non-rebated door leaves

can be changed to hinges and strike plate in black, white or gold for non-rebated door leaves

magnetic stop (buffer) ¹⁾
(available in six colours p. 149) (while supplies last)

PL2112 standard +15% on the door price before additional charges

glulam stiles

PAINTED



TITANIUM WHITE UV

AVAILABLE SOLUTIONS (pp. 154-165)

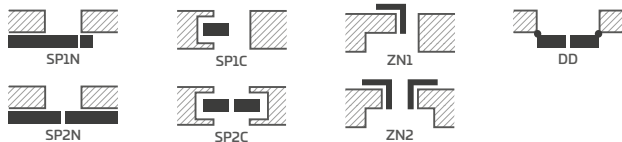

AVAILABLE DOOR LEAF WIDTHS



¹⁾ the use of a magnetic door stop makes it impossible to use a drop down seal and a ventilation undercut, and vice versa

²⁾ only for non-rebated door leaves



PEONIA

REBATED, NON-REBATED AND REVERSE PAINTED DOORS



PEONIA 1 with BELLA SLIM glossy brass handle, decorative crosshead and pilasters³⁾



PEONIA 1



PEONIA 2



PEONIA 3



Double-sided stick-on muntin
25 mm



PEONIA 4



PEONIA 5



PEONIA 6

PEONIA 2 with CUBE black matte handle, with decorative crosshead and pilasters³⁾



DESIGN

- rebated, non-rebated or reverse door leaf in STILE technology for an additional charge
- MDF stiles and rails coated with a facing layer and painted with UV-resistant varnish
- optional, for an additional charge, glulam stiles covered with HDF and MDF boards
- 16 mm thick HDF panels, moulded and coated with UV resistant varnish
- double-sided muntin applied to glass, 25 mm wide and of respective heights: vertical 12 mm and horizontal 8 mm
- optional door frame extension panels and a crosshead with pilasters are available for an additional charge, pp. 151-153
- the door can be trimmed by a customer; go to p. 149 for details

FINISH

- door leaves and door frames coated with water-based UV hardened varnish for high resistance to adverse use conditions

HARDWARE

- rebated door leaves: three silver 2-pin hinges adjusted horizontally
- two (third for an additional charge) concealed hinges in a non-rebated door leaf, painted in silver (optionally black, white or gold – for an additional charge); hinges supplied with and included in the price of the door frame
- latch and pin lock in a rebated door leaf and a key-locked magnetic lock (latch and pin lock as an option) in a non-rebated door leaf, thumb turn cylinder, economy, with a silver blockade; optionally, for an additional charge, a black, white or gold magnetic lock

GLAZING

- tempered glass, frosted or clear as a standard and, for an additional charge, laminated VSG 221 safety glass frosted or black plain on both sides, or decorative tempered glass 4 mm relief and point **NEW** (Relief and point glass are smooth on one side)
- possibility to change the glazing side to REVERSE (standard glazing for OBTVERSE)

ADDITIONAL CHARGES

factory pre-drilled through holes for handles (split handles) ordered together with the door leaf

reverse door leaf

enhanced airflow trim standard or mini, ventilation undercut standard or mini (p. 149)

"100" rebated and non-rebated door leaf

metal hinge casings in the rebated door leaf (brushed nickel, patina, polished chrome, polished brass, white and black)

VSG 221 laminated safety glass, clear on both sides or decorative glass

drop down seal ¹⁾

can be replaced with a black, white or gold magnetic lock for non-rebated door leaves

can be changed to hinges and strike plate in black, white or gold for non-rebated door leaves

magnetic stop (buffer) ¹⁾
(available in six colours p. 149) (while supplies last)

PL2112 standard +15% on the door price before additional charges

glulam stiles

PAINTED



TITANIUM WHITE UV

AVAILABLE SOLUTIONS (pp. 154-165)

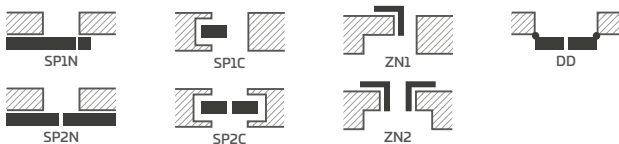

AVAILABLE DOOR LEAF WIDTHS

60 65 70 75 80N²⁾ 80 85 90 95 100

¹⁾ the use of a magnetic door stop makes it impossible to use a drop down seal and a ventilation undercut, and vice versa

²⁾ only for non-rebated door leaves

³⁾ decorative crosshead with pilasters for an additional charge, p. 151



MISKANT

REBATED, NON-REBATED AND REVERSE PAINTED DOORS



MISKANT 2 with BELLA SLIM black matte handle



MISKANT 1



MISKANT 2



MISKANT 3



Black lines 18 mm wide
silk-screen painted



MISKANT 4



MISKANT 5



MISKANT 6

MISKANT 4 with BELLA SLIM black matte handle



DESIGN

- rebated, non-rebated or reverse door leaf in STILE technology for an additional charge
- MDF stiles and rails coated with a facing layer and painted with UV-resistant varnish
- optional, for an additional charge, glulam stiles covered with HDF and MDF boards
- optional door frame extension panels and a crosshead with pilasters are available for an additional charge, pp. 151-153
- the door can be trimmed by a customer; go to p. 149 for details

FINISH

- door leaves and door frames coated with water-based UV hardened varnish for high resistance to adverse use conditions

HARDWARE

- rebated door leaves: three silver 2-pin hinges adjusted horizontally
- two (third for an additional charge) concealed hinges in a non-rebated door leaf, painted in silver (optionally black, white or gold – for an additional charge); hinges supplied with and included in the price of the door frame
- latch and pin lock in a rebated door leaf and a key-locked magnetic lock (latch and pin lock as an option) in a non-rebated door leaf, thumb turn cylinder, economy, with a silver blockade; optionally, for an additional charge, a black, white or gold magnetic lock

GLAZING

- tempered frosted glass (MISKANT 2, 4, 6) or clear glass (MISKANT 1, 3, 5), 4 mm thick or, for an additional charge, VSG laminated glass with internal decorative pattern
- possibility to change the glazing side to REVERSE (standard glazing for OBERSE)
- black screen printed lines on one side of glass with a width (thickness) of 18 mm

STANDARD "OBERSE" GLAZING

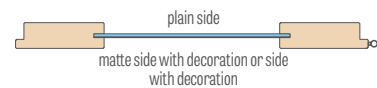

"REVERSE" GLAZING MADE TO ORDER



PAINTED



TITANIUM WHITE UV

AVAILABLE SOLUTIONS (pp. 154-165)

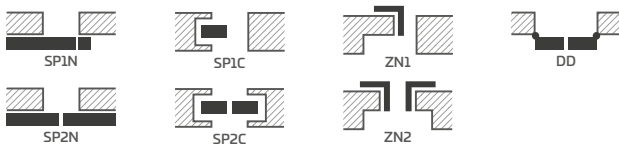

AVAILABLE DOOR LEAF WIDTHS



ADDITIONAL CHARGES

factory pre-drilled through holes for handles (split handles) ordered together with the door leaf

reverse door leaf

VSG laminated glass with internal decorative pattern in black or white

enhanced airflow trim standard or mini, ventilation undercut standard or mini (p. 149)

"100" rebated and non-rebated door leaf

metal hinge casings in the rebated door leaf (brushed nickel, patina, polished chrome, polished brass, white and black)

drop down seal¹⁾

can be replaced with a black, white or gold magnetic lock for non-rebated door leaves

can be changed to hinges and strike plate in black, white or gold for non-rebated door leaves

magnetic stop (buffer)¹⁾

(available in six colours p. 149) (while supplies last)

glulam stiles

¹⁾ the use of a magnetic door stop makes it impossible to use a drop down seal and a ventilation undercut, and vice versa

²⁾ only for non-rebated door leaves



NEMEZJA

REBATED, NON-REBATED AND REVERSE PAINTED DOORS



NEMEZJA 14 with BELLA SLIM glossy brass handle, with decorative crosshead and pilasters³⁾



NEMEZJA 4



NEMEZJA 6



NEMEZJA 7



NEMEZJA 8



NEMEZJA 9

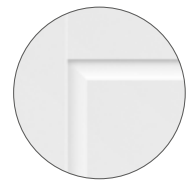

chamfered panel



NEMEZJA 10



NEMEZJA 11



NEMEZJA 12



NEMEZJA 15



NEMEZJA 16

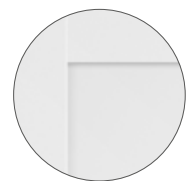

NEMEZJA 16
straight panel

NEMEZJA 8 with BELLA SLIM brass glossy handle



DESIGN

- rebated, non-rebated or reverse door leaf in STILE technology for an additional charge
- MDF stiles and rails coated with a facing layer and painted with UV-resistant varnish
- optional, for an additional charge, glulam stiles covered with HDF and MDF boards
- 16 mm thick bevelled and plain HDF panels (NEMEZJA 15) painted with UV-resistant varnish
- optional door frame extension panels and a crosshead with pilasters are available for an additional charge, pp. 151-153
- the door can be trimmed by a customer, go to p. 149 for details

FINISH

- door leaves and door frames coated with water-based UV hardened varnish for high resistance to adverse use conditions

HARDWARE

- rebated door leaves: three silver 2-pin hinges adjusted horizontally
- two (third for an additional charge) concealed hinges in a non-rebated door leaf, painted in silver (optionally black, white or gold – for an additional charge); hinges supplied with and included in the price of the door frame
- latch and pin lock in a rebated door leaf and a key-locked magnetic lock (latch and pin lock as an option) in a non-rebated door leaf, thumb turn cylinder, economy, with a silver blockade; optionally, for an additional charge, a black, white or gold magnetic lock

GLAZING

- tempered glass, frosted or clear as a standard and, for an additional charge, laminated VSG 221 safety glass frosted or black plain on both sides, or decorative tempered glass 4 mm relief and point **NEW** for NEMEZJA 4, 7, 11, 15 (Relief and point glass are smooth on one side)
- possibility to change the glazing side to REVERSE (standard glazing for OBVERSE)

ADDITIONAL CHARGES

factory pre-drilled through holes for handles (split handles) ordered together with the door leaf

reverse door leaf

enhanced airflow trim standard or mini, ventilation undercut standard or mini (p. 149)

"100" rebated and non-rebated door leaf

metal hinge casings in the rebated door leaf (brushed nickel, patina, polished chrome, polished brass, white and black)

VSG 221 laminated safety glass, clear on both sides or decorative glass

drop down seal ¹⁾

can be replaced with a black, white or gold magnetic lock for non-rebated door leaves

can be changed to hinges and strike plate in black, white or gold for non-rebated door leaves

magnetic stop (buffer) ¹⁾

(available in six colours p. 149) (while supplies last)

PL2112 standard

+15% on the door price before additional charges

glulam stiles

PAINTED



TITANIUM WHITE UV

AVAILABLE SOLUTIONS (pp. 154-165)

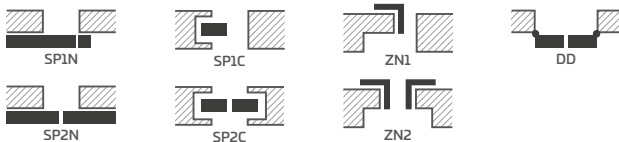

AVAILABLE DOOR LEAF WIDTHS

60 65 70 75 80N²⁾ 80 85 90 95 100

¹⁾ the use of a magnetic door stop makes it impossible to use a drop down seal and a ventilation undercut, and vice versa

²⁾ only for non-rebated door leaves

³⁾ decorative crosshead with pilasters for an additional charge, p. 151



LAURENCJA

REBATED, NON-REBATED PAINTED DOORS



LAURENCJA 1 with BELLA SLIM black matte handle, with VSG glazing black



LAURENCJA 1



LAURENCJA 2



LAURENCJA 3



LAURENCJA 4



LAURENCJA 5



LAURENCJA 6

LAURENTIA 1 with a BELLA SLIM black matte handle, and VSG 221 laminated glass, black



DESIGN

- rebated, non-rebated door leaf made in STILE technology
- MDF stiles and rails coated with a facing layer and painted with UV-resistant varnish
- optional, for an additional charge, glulam stiles covered with HDF and MDF boards
- 4 mm thick HDF panels, moulded and coated with UV-resistant varnish
- optional door frame extension panels and a crosshead with pilasters are available for an additional charge, pp. 151-153
- the door can be trimmed by a customer, go to p. 149 for details

FINISH

- door leaves and door frames coated with water-based UV hardened varnish for high resistance to adverse use conditions

HARDWARE

- rebated door leaves: three silver 2-pin hinges adjusted horizontally
- two (third for an additional charge) concealed hinges in a non-rebated door leaf, painted in silver (optionally black, white or gold – for an additional charge); hinges supplied with and included in the price of the door frame
- latch and pin lock in a rebated door leaf and a key-locked magnetic lock (latch and pin lock as an option) in a non-rebated door leaf, thumb turn cylinder, economy, with a silver blockade; optionally, for an additional charge, a black, white or gold magnetic lock

GLAZING

- Frosted or transparent glass as standard, and custom-made frosted or black VSG 221 laminated safety glass, plain on both sides
- possibility to change the glazing side to REVERSE (standard glazing for OBVERSE)

ADDITIONAL CHARGES

factory pre-drilled through holes for handles (split handles) ordered together with the door leaf

enhanced airflow trim standard or mini, ventilation undercut standard or mini (p. 149)

"100" rebated and non-rebated door leaf

metal hinge casings in the rebated door leaf (brushed nickel, patina, polished chrome, polished brass, white and black)

VSG 221 laminated safety glass, plain on both sides

drop down seal ¹⁾

can be replaced with a black, white or gold magnetic lock for non-rebated door leaves

can be changed to hinges and strike plate in black, white or gold for non-rebated door leaves

magnetic stop (buffer) ¹⁾
(available in six colours p. 149) (while supplies last)

glulam stiles

PAINTED



TITANIUM WHITE UV

AVAILABLE SOLUTIONS (pp. 154-165)

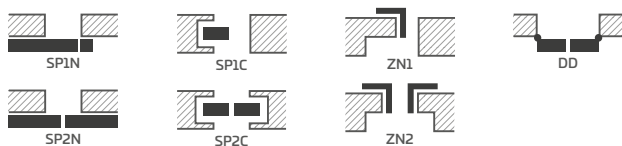

AVAILABLE DOOR LEAF WIDTHS



¹⁾ the use of a magnetic door stop makes it impossible to use a drop down seal and a ventilation undercut, and vice versa

²⁾ only for non-rebated door leaves



BALDUR

REBATED, NON-REBATED AND REVERSE PAINTED DOORS



BALDUR 1 with BELLA PREMIUM black matte handle, and VSG 441 laminated glass, black



BALDUR 1



BALDUR 2



BALDUR 3



BALDUR 4



BALDUR 5



BALDUR 6



BALDUR 7



BALDUR 8

BALDUR 7 with CUBE PREMIUM black matte handle



DESIGN

- rebated, non-rebated or reverse door leaf
- inner MDF stile covered with two HDF boards
- optionally for an additional charge internal timber stiles and top rail, MDF bottom rail, covered with two HDF boards
- honeycomb stabilising filling or solid core filling for an additional charge
- optional door frame extension panels and a crosshead with pilasters are available for an additional charge, pp. 151-153
- The door can be trimmed by a customer, go to p. 149 for details (not for BALDUR1, 3, 5)

FINISH

- door leaves and door frames coated with water-based UV hardened varnish for high resistance to adverse use conditions
- door leaf edge made in standard or non-rebated technology
- the BALDUR 1 sliding systems have a visible (17 mm high) aluminium or black coloured profile in the lower part of the glass pane

HARDWARE

- three pin mortise hinges in a rebated door leaf
- two (third for an additional charge) concealed hinges in the non-rebated door leaf and two hinges in the reverse leaf (third for an additional charge) painted in silver (black, white or gold for an additional charge); hinges are supplied and priced with the door frame
- a latch and pin lock in the rebated door leaf and a magnetic lock (latch and pin lock as an option) in the non-rebated door leaf, optionally: key-locked, thumb turn cylinder, economy or with a silver blockade; or optionally, for an additional charge, a black, white or gold magnetic lock
- a magnetic lock in the reversed-swing door, optionally: key-locked, thumb turn cylinder, economy or with a silver blockade; or optionally, for an additional charge, a black, white or gold magnetic lock

GLAZING

- **BALDUR 1, 3, 5: VSG/ESG 441 laminated and tempered safety glass as standard, frosted or black, plain on both sides**
- fixed glazing widths: BALDUR 1 – 50 mm, BALDUR 3, 5 – 210 mm

ADDITIONAL CHARGES

reverse door leaf

solid core filling

enhanced airflow trim standard or mini, ventilation undercut standard or mini (p. 149)

"100" rebated and non-rebated door leaf

additional bottom allowing the user to shorten the leaf up to 8 cm (not applicable to BALDUR 1, 3, 5)

metal hinge casings in the rebated door leaf (brushed nickel, patina, polished chrome, polished brass, white and black)

drop down seal ²⁾ (not for BALDUR 1, 3, 5)

can be replaced with a black, white or gold magnetic lock for non-rebated and reverse leaves

can be changed to hinges and strike plate in black, white or gold for non-rebated door leaves

magnetic stop (buffer) ²⁾
(available in six colours p. 149) (while supplies last)

internal wooden stile (sides and top, bottom MDF)

PL2112 standard

PAINTED



TITANIUM WHITE UV

AVAILABLE SOLUTIONS^{1) 3)} (pp. 154-165)

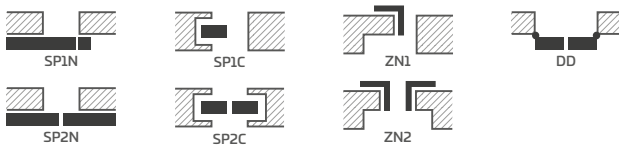

AVAILABLE DOOR LEAF WIDTHS



VENTILATION UNDERCUT

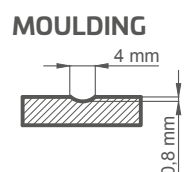
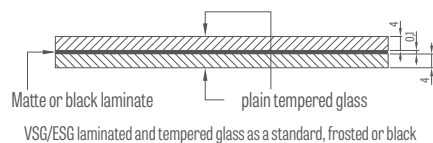
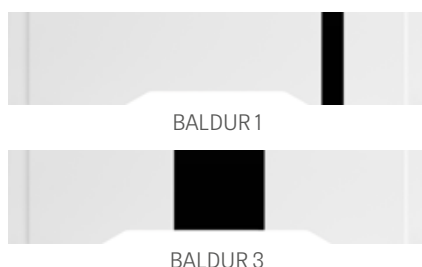

¹⁾ the BALDUR 1, 3, 5 models are not available with sliding systems or double doors

²⁾ the use of a magnetic door stop makes it impossible to use a drop down seal and a ventilation undercut, and vice versa

³⁾ the BALDUR 1 model is not available with pocket systems

⁴⁾ only for non-rebated and reversed swing doors

⁵⁾ BALDUR 1 only, non-rebated and reversed swing



ANUBIS

REBATED, NON-REBATED AND REVERSE PAINTED DOORS



ANUBIS 1 painted PL2112 with BELLA SLIM chrome glossy handle



ANUBIS 1



ANUBIS 2



ANUBIS 3



ANUBIS 4



ANUBIS 5

ANUBIS 8 BELLA SLIM shiny brass handle



TITANIUM WHITE UV

AVAILABLE SOLUTIONS (pp. 154-165)

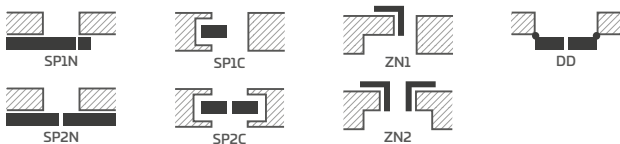

AVAILABLE DOOR LEAF WIDTHS



DESIGN

- rebated, non-rebated or reverse door leaf
- inner MDF stile covered with two HDF boards
- optionally for an additional charge internal timber stiles and top rail, MDF bottom rail, covered with two HDF boards
- honeycomb stabilising filling or solid core filling for an additional charge
- optional door frame extension panels and a crosshead with pilasters are available for an additional charge, pp. 151-153
- the door can be trimmed by a customer, go to p. 149 for details

FINISH

- door leaves and door frames coated with water-based UV hardened varnish for high resistance to adverse use conditions
- door leaf edge made in standard or non-rebated technology

HARDWARE

- three pin mortise hinges in a rebated door leaf
- two (third for an additional charge) concealed hinges in the non-rebated door leaf and two hinges in the reverse leaf (third for an additional charge) painted in silver (black, white or gold for an additional charge); hinges are supplied and priced with the door frame
- a latch and pin lock in the rebated door leaf and a magnetic lock (latch and pin lock as an option) in the non-rebated door leaf, optionally: key-locked, thumb turn cylinder, economy or with a silver blockade; or optionally, for an additional charge, a black, white or gold magnetic lock
- a magnetic lock in the reversed-swing door, optionally: key-locked, thumb turn cylinder, economy or with a silver blockade; or optionally, for an additional charge, a black, white or gold magnetic lock

MOULDING

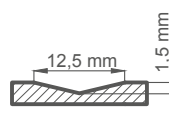

ADDITIONAL CHARGES

- reverse door leaf
- solid core filling
- enhanced airflow trim standard or mini, ventilation undercut standard or mini (p. 149)
- "100" rebated and non-rebated door leaf
- additional bottom rail (can be trimmed by a customer up to max 8 cm)
- metal hinge casings in the rebated door leaf (brushed nickel, patina, polished chrome, polished brass, white and black)
- drop down seal ¹⁾
- can be replaced with a black, white or gold magnetic lock for non-rebated and reverse leaves
- can be changed to hinges and strike plate in black, white or gold for non-rebated door leaves
- magnetic stop (buffer) ¹⁾
(available in six colours p. 149) (while supplies last)
- internal wooden stile (sides and top, bottom MDF)
- PL2112 standard

¹⁾ the use of a magnetic door stop makes it impossible to use a drop down seal and a ventilation undercut, and vice versa

²⁾ only for non-rebated and reversed swing doors



UNO PREMIUM

REBATED, NON-REBATED AND REVERSE PAINTED DOORS



UNO PREMIUM, BELLA SLIM glossy brass handle

Frame side view: non-rebated door, 8 cm architrave, frame joints at 90°



Frame side view: rebated door, 8 cm architrave, frame joints at 45°



Hinge side view: rebated door, 6 cm architrave, frame joints at 45°



UNO PREMIUM with black matte CUBE handle



TITANIUM WHITE UV

AVAILABLE SOLUTIONS (pp. 154-165)

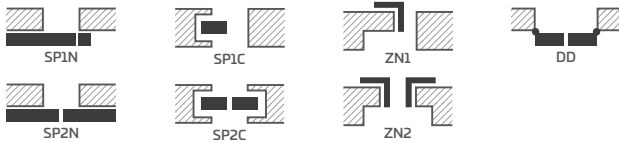

AVAILABLE DOOR LEAF WIDTHS



DESIGN

- rebated, non-rebated or reverse door leaf
- inner MDF stile covered with two HDF boards
- optionally for an additional charge internal timber stiles and top rail, MDF bottom rail, covered with two HDF boards
- honeycomb stabilising filling or solid core filling for an additional charge
- optional door frame extension panels and a crosshead with pilasters are available for an additional charge, pp. 151-153
- the door can be trimmed by a customer, go to p. 149 for details

FINISH

- door leaves and door frames coated with water-based UV hardened varnish for high resistance to adverse use conditions
- door leaf edge made in standard technology

HARDWARE

- three pin mortise hinges in a rebated door leaf
- two (third for an additional charge) concealed hinges in the non-rebated door leaf and two hinges in the reverse leaf (third for an additional charge) painted in silver (black, white or gold for an additional charge); hinges are supplied and priced with the door frame
- a latch and pin lock in the rebated door leaf and a magnetic lock (latch and pin lock as an option) in the non-rebated door leaf, optionally: key-locked, thumb turn cylinder, economy or with a silver blockade; or optionally, for an additional charge, a black, white or gold magnetic lock
- a magnetic lock in the reversed-swing door, optionally: key-locked, thumb turn cylinder, economy or with a silver blockade; or optionally, for an additional charge, a black, white or gold magnetic lock

ADDITIONAL CHARGES

reverse door leaf

solid core filling

enhanced airflow trim standard or mini, ventilation undercut standard or mini (p. 149)

"100" rebated and non-rebated door leaf

"110" rebated and non-rebated door leaf

additional bottom rail (can be trimmed by a customer up to max 8 cm)

metal hinge casings in the rebated door leaf (brushed nickel, patina, polished chrome, polished brass, white and black)

drop down seal ¹⁾

can be replaced with a black, white or gold magnetic lock for non-rebated and reverse leaves

can be changed to hinges and strike plate in black, white or gold for non-rebated door leaves

magnetic stop (buffer) ¹⁾
(available in six colours p. 149) (while supplies last)

stainless steel porthole: "chrome" polished or "satin" brushed; frosted decormat glass, non-tinted glass; porthole ID 235 mm; external 350 mm)

internal wooden stile (sides and top, bottom MDF)

PL2112 standard

¹⁾ the use of a magnetic door stop makes it impossible to use a drop down seal and a ventilation undercut, and vice versa

²⁾ only for non-rebated and reversed swing doors

TURAN

REBATED, NON-REBATED AND REVERSE PAINTED DOORS



finalist
of the competition



2019



TURAN 8^{*)} in standard PL2112, with bonded glazing VSG 221 black, with QUANTA FIT black matte handle



TURAN 1



TURAN 2



TURAN 3



TURAN 4



TURAN 5



TURAN 6



TURAN 7^{*)}



TURAN 8

^{*)} the photo shows the REVERS version

TURAN 6 with BELLA SLIM round black matte handle



DESIGN

- rebated, non-rebated or reverse door leaf in STILE technology for an additional charge
- MDF stiles and rails coated with a facing layer and painted with UV-resistant varnish
- optional, for an additional charge, glulam stiles covered with HDF and MDF boards
- in TURAN 8 model, the panel is made of moisture-resistant HDF board 3 mm thick, applied to glass on both sides. The edge of the panel is always in the TITANIUM WHITE UV colour.³⁾
- 16 mm thick MDF panels, moulded and coated with UV resistant varnish
- optional door frame extension panels and a crosshead with pilasters are available for an additional charge, pp. 151-153
- the door can be trimmed by a customer, go to p. 149 for details

FINISH

- door leaves and door frames coated with water-based UV hardened varnish for high resistance to adverse use conditions

HARDWARE

- rebated door leaves: three silver 2-pin hinges adjusted horizontally
- two (third for an additional charge) concealed hinges in a non-rebated door leaf, painted in silver (optionally black, white or gold – for an additional charge); hinges supplied with and included in the price of the door frame
- latch and pin lock in a rebated door leaf and a key-locked magnetic lock (latch and pin lock as an option) in a non-rebated door leaf, thumb turn cylinder, economy, with a silver blockade; optionally, for an additional charge, a black, white or gold magnetic lock

GLAZING

- TURAN 1 and TURAN 8 models: tempered frosted or clear glass 4 mm and for an additional charge: VSG 221 frosted or black safety glass, plain on both sides or decorative tempered glass 4 mm relief and point **NEW** for TURAN 1 (Relief and point glass are smooth on one side)
- TURAN 7 model available with a mirror on one side. Other side – varnished board TITANIUM WHITE UV. Obverse – mirror on the hinge side.
- TURAN 8 model fixed glazing width – 50 mm

ADDITIONAL CHARGES

factory pre-drilled through holes for handles (split handles) ordered together with the door leaf

reverse door leaf

enhanced airflow trim standard or mini, ventilation undercut standard or mini (p. 149)

"100" rebated and non-rebated door leaf

metal hinge casings in the rebated door leaf (brushed nickel, patina, polished chrome, polished brass, white and black)

VSG 221 laminated safety glass, plain on both sides (applies to TURAN 1 and TURAN 8) or decorative glass

drop down seal¹⁾

can be replaced with a black, white or gold magnetic lock for non-rebated door leaves

can be changed to hinges and strike plate in black, white or gold for non-rebated door leaves

magnetic stop (buffer)¹⁾

(available in six colours p. 149) (while supplies last)

PL2112 standard

+15% on the door price before additional charges

glulam stiles



TITANIUM WHITE UV

AVAILABLE SOLUTIONS (pp. 154-165)

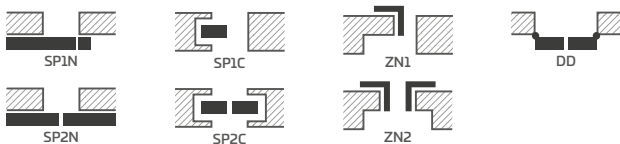

AVAILABLE DOOR LEAF WIDTHS

60 70 80N²⁾ 80 90 100

MOULDING

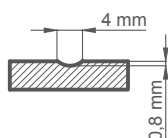

¹⁾ the use of a magnetic door stop makes it impossible to use a drop down seal and a ventilation undercut, and vice versa

²⁾ only for non-rebated door leaves



MILDA

REBATED, NON-REBATED AND REVERSE PAINTED DOORS

product recommended
for the competition



2019



MILDA 4 with CUBE PREMIUM black matte handle



MILDA 1



MILDA 2



MILDA 3



MILDA 4



MILDA 5

MILDA 2 with CUBE PREMIUM black matte handle



TITANIUM WHITE UV

AVAILABLE SOLUTIONS (pp. 154-165)

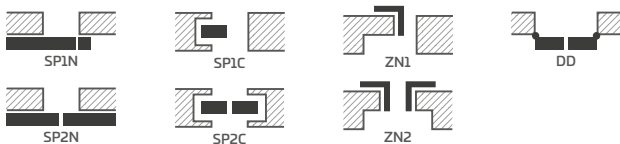

AVAILABLE DOOR LEAF WIDTHS



DESIGN

- rebated, non-rebated or reverse door leaf
- inner MDF stile covered with two HDF boards
- optionally for an additional charge internal timber stiles and top rail, MDF bottom rail, covered with two HDF boards
- honeycomb stabilising filling or solid core filling for an additional charge
- optional door frame extension panels and a crosshead with pilasters are available for an additional charge, pp. 151-153
- the door can be trimmed by a customer, go to p. 149 for details

FINISH

- door leaves and door frames coated with water-based UV hardened varnish for high resistance to adverse use conditions
- door leaf edge made in standard or non-rebated technology

HARDWARE

- three pin mortise hinges in a rebated door leaf
- two (third for an additional charge) concealed hinges in the non-rebated door leaf and two hinges (third for an additional charge) in the reverse swing leaf painted in silver (black, white or gold for an additional charge); hinges are supplied and priced with the door frame
- a latch and pin lock in the rebated door leaf and a magnetic lock (latch and pin lock as an option) in the non-rebated door leaf, optionally: key-locked, thumb turn cylinder, economy or with a silver blockade; or optionally, for an additional charge, a black, white or gold magnetic lock
- a magnetic lock in the reversed-swing door, optionally: key-locked, thumb turn cylinder, economy or with a silver blockade; or optionally, for an additional charge, a black, white or gold magnetic lock

MOULDING

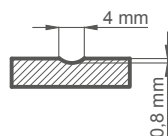

ADDITIONAL CHARGES

- reverse door leaf
- solid core filling
- enhanced airflow trim standard or mini, ventilation undercut standard or mini (p. 149)
- "100" rebated and non-rebated door leaf
- additional bottom rail (can be trimmed by a customer up to max 8 cm)
- metal hinge casings in the rebated door leaf (brushed nickel, patina, polished chrome, polished brass, white and black)
- drop down seal ¹⁾
- can be replaced with a black, white or gold magnetic lock for non-rebated and reverse leaves
- can be changed to hinges and strike plate in black, white or gold for non-rebated door leaves
- magnetic stop (buffer) ¹⁾
(available in six colours p. 149) (while supplies last)
- internal wooden stile (sides and top, bottom MDF)
- PL2112 standard

¹⁾ the use of a magnetic door stop makes it impossible to use a drop down seal and a ventilation undercut, and vice versa

²⁾ only for non-rebated and reversed swing doors



SYLENA

REBATED, NON-REBATED AND REVERSE PAINTED DOORS



SYLENA 5 with BELLA SLIM shiny brass handle



SYLENA 1



SYLENA 2



SYLENA 3



SYLENA 4



SYLENA 5



SYLENA 6



SYLENA 7



SYLENA 8

MISKANT 3 with BELLA SLIM black matte handle



DESIGN

- rebated, non-rebated or reverse door leaf
- inner MDF stile covered with two HDF boards
- optionally for an additional charge internal timber stiles and top rail, MDF bottom rail, covered with two HDF boards
- honeycomb stabilising filling or solid core filling for an additional charge
- optional door frame extension panels and a crosshead with pilasters are available for an additional charge, pp. 151-153
- the door can be trimmed by a customer, go to p. 149 for details

FINISH

- door leaves and door frames coated with water-based UV hardened varnish for high resistance to adverse use conditions
- door leaf edge made in standard or non-rebated technology

HARDWARE

- three pin mortise hinges in a rebated door leaf
- two (third for an additional charge) concealed hinges in the non-rebated door leaf and two hinges (third for an additional charge) in the reverse swing leaf painted in silver (black, white or gold for an additional charge); hinges are supplied and priced with the door frame
- a latch and pin lock in the rebated door leaf and a magnetic lock (latch and pin lock as an option) in the non-rebated door leaf, optionally: key-locked, thumb turn cylinder, economy or with a silver blockade; or optionally, for an additional charge, a black, white or gold magnetic lock
- a magnetic lock in the reversed-swing door, optionally: key-locked, thumb turn cylinder, economy or with a silver blockade; or optionally, for an additional charge, a black, white or gold magnetic lock

MOULDING

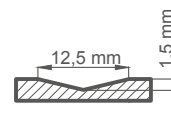

ADDITIONAL CHARGES

reverse door leaf

solid core filling

enhanced airflow trim standard or mini, ventilation undercut standard or mini (p. 149)

"100" rebated and non-rebated door leaf

additional bottom rail (can be trimmed by a customer up to max 8 cm)

metal hinge casings in the rebated door leaf (brushed nickel, patina, polished chrome, polished brass, white and black)

drop down seal ¹⁾

can be replaced with a black, white or gold magnetic lock for non-rebated and reverse leaves

can be changed to hinges and strike plate in black, white or gold for non-rebated door leaves

magnetic stop (buffer) ¹⁾
(available in six colours p. 149) (while supplies last)

internal wooden stile (sides and top, bottom MDF)

PL2112 standard



TITANIUM WHITE UV

AVAILABLE SOLUTIONS (pp. 154-165)

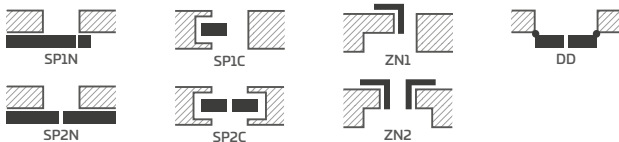

AVAILABLE DOOR LEAF WIDTHS

60 70 80N²⁾ 80 90 100

¹⁾ the use of a magnetic door stop makes it impossible to use a drop down seal and a ventilation undercut, and vice versa

²⁾ only for non-rebated and reversed swing doors



INLAYS

DECORATIVE INSERT FLUSH WITH THE FACING SURFACE



ALTAMURA 1 with BLACK ST CPL facing layer; with LUX 614 inlay; with QUANTA FIT black matte handle



NEW

INTARSJA LUX RED, BLUE and OLIVE

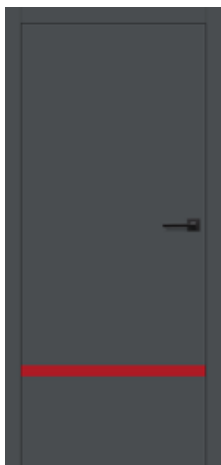

inlay LUX 617

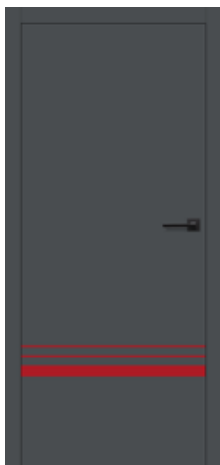

inlay LUX 618

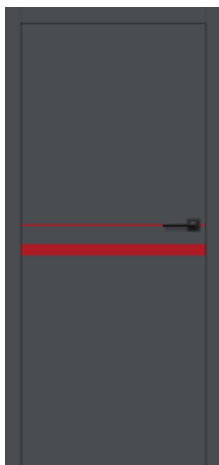

inlay LUX 619



inlay LUX 620



inlay LUX 621

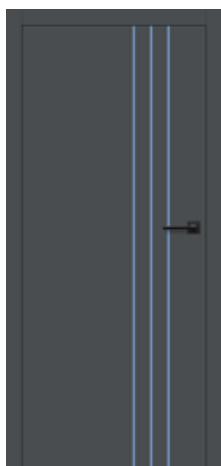

inlay LUX 703

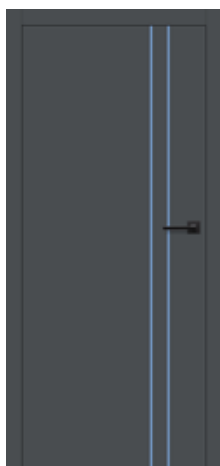

inlay LUX 704

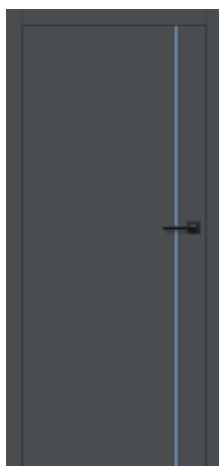

inlay LUX 712

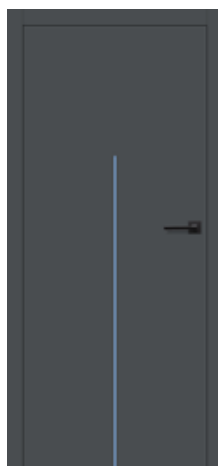

inlay LUX 713

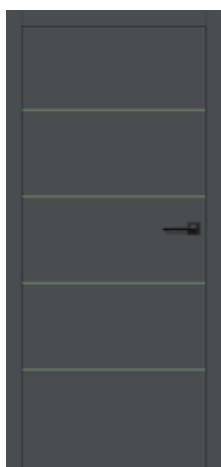

inlay LUX 807

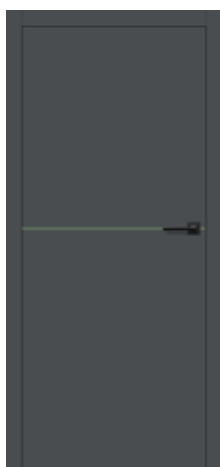

inlay LUX 814

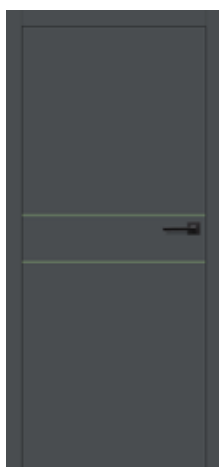

inlay LUX 816

Door frame and leaf ANTHRACITE CPL

INLAYS are located on both sides of the leaf and are flush with its surface. The inlay width is 8 mm or 50 mm. Inlays in red, blue and olive are available in all combinations, as are inlays in black, steel, gold, oak or copper.

Available colours of the LUX INLAY:
 brushed steel LUX100 black LUX200,
 oak (compatible with Oak CLASSIC CPL 0.2 and 0.7) LUX300,
 brushed gold LUX400 brushed copper LUX500,
 red LUX600 blue LUX700, olive LUX800

You can order the presented INLAYS as options for an additional charge on the following models available to PL and PL2112 standards (if available):

- UNO PREMIUM facing
- ALTAMURA 1
- FORTECA RC2 & RC3
- HERSE SET EKO 30 dB
- HERSE SET 32 dB
- HERSE SET AKUSTIC 39 dB
- LEDA EI30, EI60





INLAYS

DECORATIVE INSERT FLUSH WITH THE FACING SURFACE

LUX INLAY BLACK



inlay LUX 217



inlay LUX 218



inlay LUX 219



inlay LUX 220



inlay LUX 221



inlay LUX 203



inlay LUX 204



inlay LUX 212



inlay LUX 213



inlay LUX 207



inlay LUX 214



inlay LUX 216

Door frame: BLACK ST CPL Door leaf: OAK CLASSIC CPL

INLAYS are located on both sides of the leaf and are flush with its surface. The inlay width is 8 mm or 50 mm.

Available colours of the LUX INLAY:
brushed steel **LUX100** black **LUX200**,
oak (compatible with Oak CLASSIC CPL 0.2 and 0.7) **LUX300**,
brushed gold **LUX400** brushed copper **LUX500**,
red **LUX600** blue **LUX700**, olive **LUX800**

You can order the presented INLAYS as options for an additional charge on the following models available to PL and PL2112 standards (if available):

- UNO PREMIUM facing
- ALTAMURA 1
- FORTEGA RC2 & RC3
- HERSE SET EKO 30 dB
- HERSE SET 32 dB
- HERSE SET AKUSTIC 39 dB
- LEDA EI30, EI60

LUX INLAY **OAK**



inlay LUX 317



inlay LUX 318



inlay LUX 319



inlay LUX 320



inlay LUX 321



inlay LUX 303



inlay LUX 304



inlay LUX 312



inlay LUX 313



inlay LUX 307



inlay LUX 314



inlay LUX 316

Door frame: OAK CLASSIC CPL 0.2 Door leaf: WHITE ST CPL

INLAYS are located on both sides of the leaf and are flush with its surface. The inlay width is 8 mm or 50 mm.

Available colours of the LUX INLAY:
 brushed steel **LUX100** black **LUX200**,
 oak (compatible with Oak CLASSIC CPL 0.2 and 0.7) **LUX300**,
 brushed gold **LUX400** brushed copper **LUX500**,
 red **LUX600** blue **LUX700**, olive **LUX800**

You can order the presented INLAYS as options for an additional charge on the following models available to PL and PL2112 standards (if available):

- UNO PREMIUM facing
- ALTAMURA 1
- FORTECA RC2 & RC3
- HERSE SET EKO 30 dB
- HERSE SET 32 dB
- HERSE SET AKUSTIC 39 dB
- LEDA EI30, EI60



INLAYS

DECORATIVE INSERT FLUSH WITH THE FACING SURFACE

LUX INLAY BRUSHED STEEL



inlay LUX 117

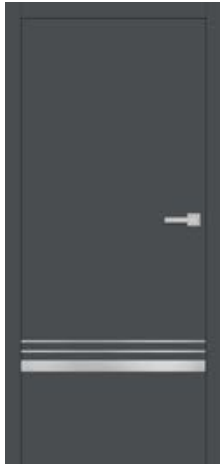

inlay LUX 118



inlay LUX 119



inlay LUX 120

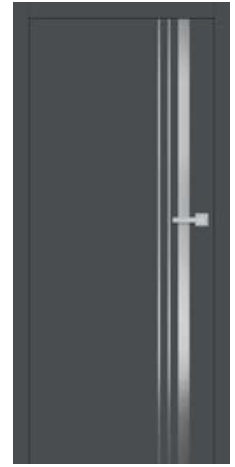

inlay LUX 121

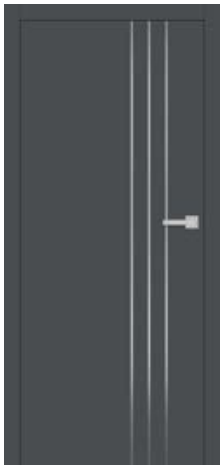

inlay LUX 103



inlay LUX 104



inlay LUX 112



inlay LUX 113

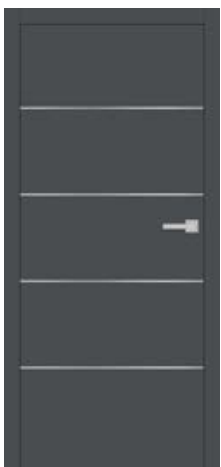

inlay LUX 107

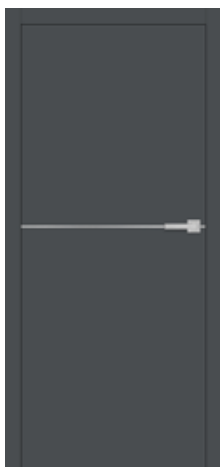

inlay LUX 114



inlay LUX 116

Door frame and leaf ANTHRACITE ST CPL

INLAYS are located on both sides of the leaf and are flush with its surface. The inlay width is 8 mm or 50 mm.

Available colours of the LUX INLAY:
brushed steel **LUX100** black **LUX200**,
oak (compatible with Oak CLASSIC CPL 0.2 and 0.7) **LUX300**,
brushed gold **LUX400** brushed copper **LUX500**,
red **LUX600** blue **LUX700**, olive **LUX800**

You can order the presented INLAYS as options for an additional charge on the following models available to PL and PL2112 standards (if available):

- UNO PREMIUM facing
- ALTAMURA 1
- FORTEGA RC2 & RC3
- HERSE SET EKO 30 dB
- HERSE SET 32 dB
- HERSE SET AKUSTIC 39 dB
- LEDA EI30, EI60

The pictures show a non-rebated door with an economy lock, the lock positions may vary on other door types.

INLAY LUX BRUSHED COPPER



inlay LUX 517



inlay LUX 518



inlay LUX 519



inlay LUX 520



inlay LUX 521



inlay LUX 503



inlay LUX 504



inlay LUX 512



inlay LUX 513



inlay LUX 507



inlay LUX 514



inlay LUX 516

Door frame and leaf NAVY BLUE ST CPL

INLAYS are located on both sides of the leaf and are flush with its surface. The inlay width is 8 mm or 50 mm.

Available colours of the LUX INLAY:
 brushed steel **LUX100** black **LUX200**,
 oak (compatible with Oak CLASSIC CPL 0.2 and 0.7) **LUX300**,
 brushed gold **LUX400** brushed copper **LUX500**,
 red **LUX600** blue **LUX700**, olive **LUX800**

You can order the presented INLAYS as options for an additional charge on the following models available to PL and PL2112 standards (if available):

- UNO PREMIUM facing
- ALTAMURA 1
- FORTECA RC2 & RC3
- HERSE SET EKO 30 dB
- HERSE SET 32 dB
- HERSE SET AKUSTIC 39 dB
- LEDA EI30, EI60



INLAYS

DECORATIVE INSERT FLUSH WITH THE FACING SURFACE

LUX INLAY BRUSHED GOLD



inlay LUX 417

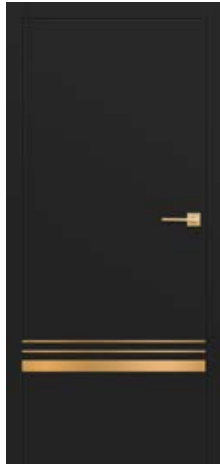

inlay LUX 418

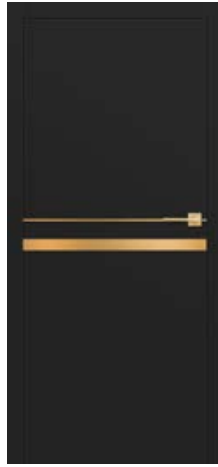

inlay LUX 419

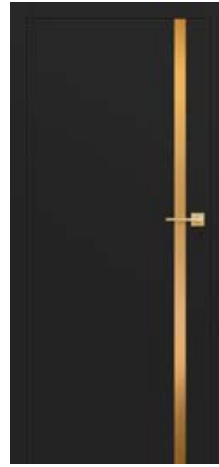

inlay LUX 420



inlay LUX 421



inlay LUX 403

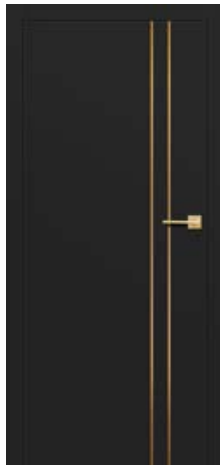

inlay LUX 404

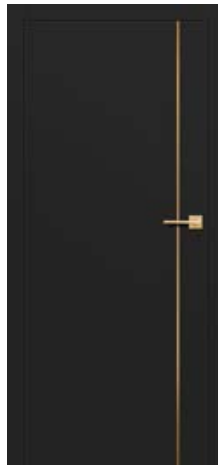

inlay LUX 412



inlay LUX 413



inlay LUX 407



inlay LUX 414

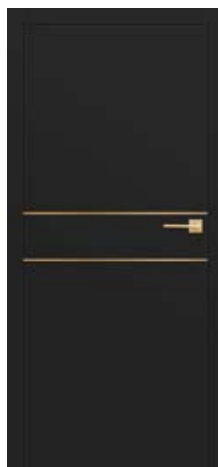

inlay LUX 416

Door frame and leaf BLACK ST CPL

INLAYS are located on both sides of the leaf and are flush with its surface. The inlay width is 8 mm or 50 mm.

Available colours of the LUX INLAY:
brushed steel **LUX100** black **LUX200**,
oak (compatible with Oak CLASSIC CPL 0.2 and 0.7) **LUX300**,
brushed gold **LUX400** brushed copper **LUX500**,
red **LUX600** blue **LUX700**, olive **LUX800**

You can order the presented INLAYS as options for an additional charge on the following models available to PL and PL2112 standards (if available):

- UNO PREMIUM facing
- ALTAMURA 1
- FORTEGA RC2 & RC3
- HERSE SET EKO 30 dB
- HERSE SET 32 dB
- HERSE SET AKUSTIC 39 dB
- LEDA EI30, EI60

The pictures show a non-rebated door with an economy lock, the lock positions may vary on other door types.

INLAYS

DECORATIVE INSERT FLUSH WITH THE FACING SURFACE



ALTAMURA 1 with BLACK ST CPL facing layer, with inlay LUX 421, with BELLA SLIM square satin brass handle



BALDUR

REBATED, NON-REBATED AND REVERSE INTERIOR DOORS



BALDUR 1 with NATUR OAK PREMIUM facing layer; door frame with BLACK ST CPL facing layer; with QUBIK black matte handle

BALDUR 1 with OAK RETRO CPL facing layer; with BLACK ST CPL door frame; with CUBE PREMIUM black matte handle



BALDUR 1

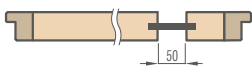

8 mm tempered safety glass or for an additional charge VSG/ESG 441 frosted glass or black glass.

BALDUR 3 with OAK ST CPL facing layer; BLACK ST CPL door frame; with CUBE PREMIUM black matte handle



BALDUR 3

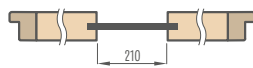

8 mm tempered safety glass or for an additional charge VSG/ESG 441 frosted glass or black glass.

NEW

BALDUR 9 with OAK CLASSIC CPL facing layer; BLACK ST CPL door frame with CUBE PREMIUM black matte handle



BALDUR 9

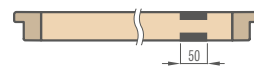

Lacobel black 4 mm glass glued into the leaf both sides and flush with the surface.

DESIGN

- rebated, non-rebated or reverse door leaf
- inner MDF stile covered with two HDF boards
- optionally for an additional charge internal timber stiles and top rail, MDF bottom rail, covered with two HDF boards
- honeycomb stabilising filling or solid core filling for an additional charge
- optional door frame extension panels and a crosshead with pilasters are available for an additional charge, pp. 151-153

FINISH

- HDF board in PREMIUM or CPL facing
- leaf edge made in the standard rebated or non-rebated technology with CPL 0.2 laminates, faced with the ABS edging, and in the same colour as the leaf only or, for an additional charge, with a standard black edge
- reverse door leaf only in with the STANDARD edge and with the PREMIUM and ST CPL facings
- the door edge faced with edging in the same colour as the door leaf plane or optionally in black plain edging (black edging with horizontal grain for the TRANSVERSE NATUR OAK PREMIUM facing). Door edge faced with black layers around a part of the circumference (two vertical edges and the top one) and next to the glass.
- rebated and non-rebated door leaf BALDUR 1 only for the WHITE ST CPL facing made optionally in the Soft technology (invisible longitudinal edge joints of the facing), requiring the use of a solid core for an additional charge. The Soft technology is not included in the PL2112 standard.
- the BALDUR 1 sliding systems have a visible 17 mm high aluminium or black coloured profile in the lower part of the glass pane

HARDWARE

- three pin mortise hinges in a rebated door leaf
- two (third for an additional charge) concealed hinges in the non-rebated door leaf and two hinges (third for an additional charge) in the reverse swing leaf painted in silver (black, white or gold for an additional charge); hinges are supplied and priced with the door frame
- a latch and pin lock in the rebated door leaf and a magnetic lock (latch and pin lock as an option) in the non-rebated door leaf, optionally: key-locked, thumb turn cylinder, economy or with a silver blockade; or optionally, for an additional charge, a black, white or gold magnetic lock
- a magnetic lock in the reversed-swing door, optionally: key-locked, thumb turn cylinder, economy or with a silver blockade; or optionally, for an additional charge, a black, white or gold magnetic lock

GLAZING

- BALDUR 1, 3: 8 mm tempered frosted glass or VSG/ESG 441 safety glass, frosted or black, plain on both sides
- BALDUR 9 **NEW** 4 mm black glass, flush with the leaf surface on both sides
- visual width of glass: BALDUR 1 and 9 – 50 mm, BALDUR 3 – 210 mm

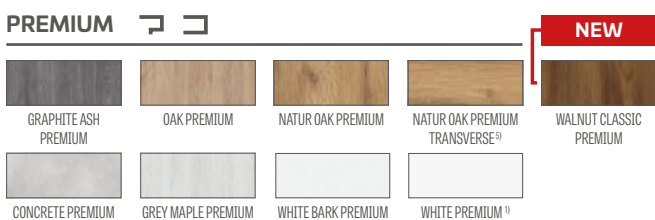

reverse door leaf

(unavailable for CPL 0.2 and for BALDUR 1 with SOFT edge)

solid core filling

enhanced airflow trim standard or mini, ventilation undercut standard or mini (p. 149)

"100" rebated and non-rebated door leaf

frosted or black VSG/ESG 441 glazing

metal hinge casings in the rebated door leaf (brushed nickel, patina, polished chrome, polished brass, white and black)

black door leaf edge finish

can be replaced with a black, white or gold magnetic lock for non-rebated and reverse leaves

change to black lock, hinges and striker plate for rebated doors

can be changed to hinges and strike plate in black, white or gold for non-rebated door leaves

magnetic stop (buffer)

(available in six colours p. 149) (while supplies last)

internal wooden stile (sides and top, bottom MDF)

PL2112 standard

+ 15% on the door price before additional charges

AVAILABLE DOOR LEAF WIDTHS



AVAILABLE SOLUTIONS 3) (pp. 154-165)



EDGE FINISH TYPES



VENTILATION UNDERCUT



¹⁾ plain white facing imitating a painted surface

²⁾ special **AntiFinger** coating to reduce dirt and fingerprints

³⁾ the BALDUR 3 model not available in sliding systems or double doors

⁴⁾ only soft version for BALDUR 1 rebated and non-rebated with WHITE ST CPL facing layer and only available for an additional charge with solid core (the Soft option not included in the PL2112 standard)

⁵⁾ comes complete with the NATUR OAK PREMIUM door frame

⁶⁾ only for non-rebated and reversed swing doors

⁷⁾ only BALDUR 1 and BALDUR 9 non-rebated and reversed swing, not available in soft edge



UNO PREMIUM

REBATED, NON-REBATED AND REVERSE INTERIOR DOORS



UNO PREMIUM with OAK PREMIUM décor, with BLACK ST CPL door frame, with CUBE PREMIUM black matte handle

UNO PREMIUM with TRANSVERSE NATUR OAK PREMIUM facing layer with CUBE black matte handle



UNO PREMIUM with GRAPHITE ASH PREMIUM facing layer with CUBE black matte handle



UNO PREMIUM with WALNUT CLASSIC PREMIUM facing layer with CUBE black matte handle



UNO PREMIUM with WHITE PREMIUM facing layer with BELLA SLIM black matte handle



DESIGN

- rebated, non-rebated or reverse door leaf
- inner MDF stile covered with two HDF boards
- optionally for an additional charge internal timber stiles and top rail, MDF bottom rail, covered with two HDF boards
- rigid honeycomb infill
- solid core filling for additional charge
- optional door frame extension panels and a crosshead with pilasters are available for an additional charge, pp. 151-153
- the door can be trimmed by a customer; go to p. 149 for details

FINISH

- HDF board with PREMIUM facing
- door leaf edge made in standard rebated or non-rebated technology
- the edge laminated in the same colour as the door leaf surface or, optionally plain black (transverse NATUR OAK PREMIUM, black edge with a transverse structure)
- insert (inlay) colour: brushed steel, black, brushed gold and CLASSIC OAK CPL with a width of 8 mm or 50 mm flush with the door leaf plane, made on both sides of the leaf, pp. 96-103

HARDWARE

- three pin mortise hinges in a rebated door leaf
- two (third for an additional charge) concealed hinges in the non-rebated door leaf and two hinges (third for an additional charge) in the reverse swing leaf painted in silver (black, white or gold for an additional charge); hinges are supplied and priced with the door frame
- a latch and pin lock in the rebated door leaf and a magnetic lock (latch and pin lock as an option) in the non-rebated door leaf, optionally: key-locked, thumb turn cylinder, economy or with a silver blockade; or optionally, for an additional charge, a black, white or gold magnetic lock
- a magnetic lock in the reversed-swing door, optionally: key-locked, thumb turn cylinder, economy or with a silver blockade; or optionally, for an additional charge, a black, white or gold magnetic lock

PREMIUM

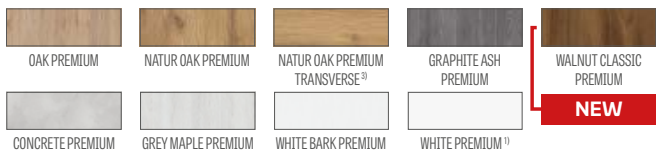

AVAILABLE DOOR LEAF WIDTHS

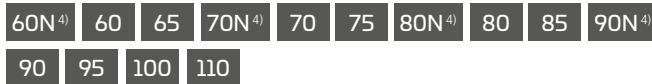

AVAILABLE SOLUTIONS (pp. 154-165)

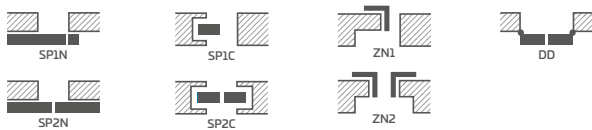

EDGE FINISH TYPES



BLACK PLAIN DOOR LEAF EDGE FINISH (for an additional charge)



BLACK HORIZONTAL DOOR LEAF EDGE FINISH (for an additional charge)



ADDITIONAL CHARGES

- reverse door leaf
- solid core filling
- door closer reinforcement
- arm door closer (silver, black, white, brown)
- additional bottom rail (can be trimmed by a customer up to max 8 cm)
- round and square metal sleeves (4 pcs); brushed nickel or patina finish, white and black
- plastic woodgrain sleeves (4 pcs)
- standard or mini enhanced airflow trim, standard or mini ventilation undercut (p. 149) or ventilation grille
- "100" rebated and non-rebated door leaf
- "110" rebated and non-rebated door leaf
- drop down seal²⁾
- metal hinge casings in the rebated door leaf (brushed nickel, patina, polished chrome, polished brass, white and black)
- stainless steel porthole: "chrome" polished or "satin" brushed; frosted decormat glass, non-tinted glass; porthole ID 235 mm external 350 mm)
- black door leaf edge finish
- can be replaced with a black, white or gold magnetic lock for non-rebated and reverse leaves
- change to black lock, hinges and striker plate for rebated doors
- can be changed to hinges and strike plate in black, white or gold for non-rebated door leaves
- magnetic stop (buffer)²⁾ (available in six colours p. 149) (while supplies last)
- internal wooden stile (sides and top, bottom MDF)
- LUX inlay; available versions p. 96-103
- PL2112 standard + 15% on the door price before additional charges

¹⁾ plain white facing imitating a painted surface

²⁾ the use of a magnetic door stop makes it impossible to use a drop down seal and a ventilation undercut, and vice versa

³⁾ comes complete with the NATUR OAK PREMIUM door frame

⁴⁾ only for non-rebated and reversed swing doors



HARDWARE

HANDLES FOR FLUSH AND PANELLED DOORS

NEW NOVA CLICK, TOPAZ CLICK handles

stainless steel, matte black



NOVA CLICK
stainless steel



NOVA CLICK
matte black



TOPAZ CLICK
stainless steel



TOPAZ CLICK
matte black

NOVA CLICK and TOPAZ CLICK handles are available in LEFT and RIGHT versions, details on page 145

NEW CORONA TIME SLIM R handle

brass matte, gunmetal, black matte



CORONA TIME SLIM R
brass matte



CORONA TIME SLIM R
gunmetal



CORONA TIME SLIM R
matte black



HANDLE CLASS PREMIUM

keyhole escutcheon, euro profile and toilet

NEW CORONA IMPERA RT handle

glossy chrome, brushed matte chrome, glossy copper, brushed matte nickel, black matte, white matte



CORONA IMPERA RT
glossy chrome



CORONA IMPERA RT
brushed matte chrome

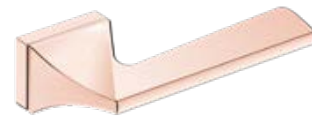

CORONA IMPERA RT
shiny copper



CORONA IMPERA RT
brushed matte nickel



CORONA IMPERA RT
matte black



CORONA IMPERA RT
white matte

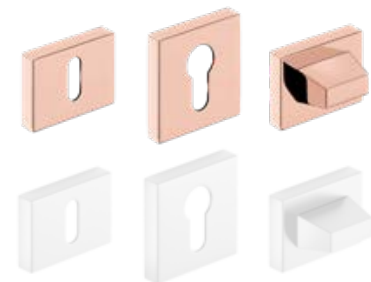

HANDLE CLASS PREMIUM

keyhole escutcheon, euro profile and toilet

HANDLES FOR FLUSH AND PANELED DOORS



NEW

CORONA ARROW R handle

glossy chrome, brushed matte chrome matte, white matte, black matte



CORONA ARROW R
glossy chrome



CORONA ARROW R
brushed matte chrome



CORONA ARROW R
matte black



CORONA ARROW R
white matte

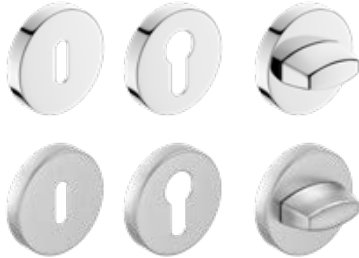

keyhole escutcheon, euro profile and toilet

NEW

CORONA ARROW Q handle

glossy chrome, brushed matte chrome matte, white matte, black matte



CORONA ARROW Q
glossy chrome



CORONA ARROW Q
brushed matte chrome



CORONA ARROW Q
matte black



CORONA ARROW Q
white matte

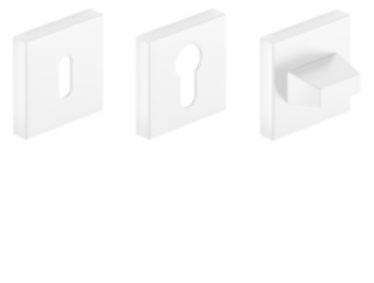

keyhole escutcheon, euro profile and toilet

NEW

CORONA MOON R SLIM handle

glossy chrome, black matte, glossy brass, brass matte



CORONA MOON R SLIM
glossy chrome



CORONA MOON R SLIM
matte black



CORONA MOON R SLIM
glossy brass



CORONA MOON R SLIM
brass matte

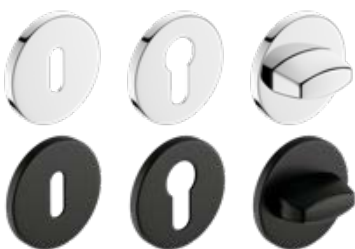

keyhole escutcheon, euro profile and toilet

keyhole escutcheon, euro profile and toilet



HANDLES FOR FLUSH AND PANELLED DOORS

NEW

QUANTA FIT, DIVA FIT, ZOJA FIT, TORA FIT handles (prestigious 6 mm thick escutcheon)

Metal-Bud

PRODUCENT KLAMEK

glossy chrome, brushed nickel, brushed brass, black matte



TORA FIT
matte black



DIVA FIT
brushed nickel



DIVA FIT
brushed brass



DIVA FIT
matte black



ZOJA FIT
brushed nickel



ZOJA FIT
brushed brass



ZOJA FIT
matte black



QUANTA FIT
glossy chrome



QUANTA FIT
brushed nickel



QUANTA FIT
brushed brass



QUANTA FIT
matte black

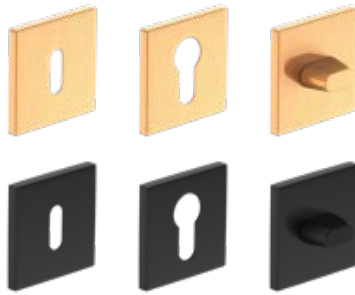
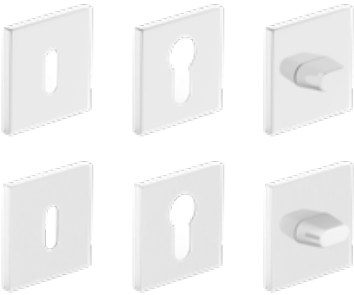

escutcheon – keyhole profile
escutcheon – euro profile
escutcheon – bathroom

BELLA SLIM SQUARE handle (prestige 6 mm faceplate)

glossy chrome, brushed matte chrome, glossy brass, satin brass, black matte

Metal-Bud

PRODUCENT KLAMEK



BELLA SLIM square
glossy chrome



BELLA SLIM square
brushed matte chrome



BELLA SLIM square
glossy brass



BELLA SLIM square
brass satin



BELLA SLIM square
matte black

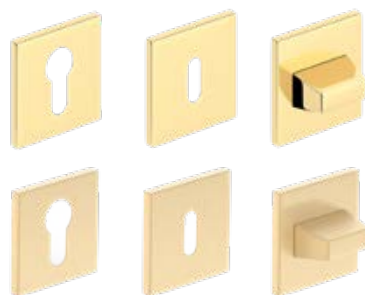
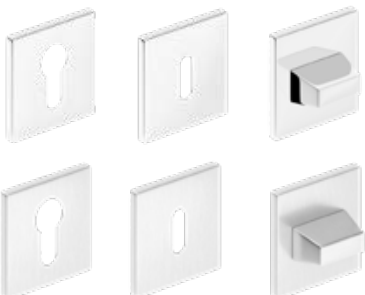

escutcheon – keyhole profile
escutcheon – euro profile
escutcheon – bathroom

HANDLE CLASS
PREMIUM

HANDLES FOR FLUSH AND PANELLED DOORS

CUBE SLIM handle (prestige 6 mm)

Metal-Bud

PRODUCENT KLAMEK

glossy chrome, brushed matte chrome, glossy brass, satin brass, black matte



CUBE SLIM
glossy chrome

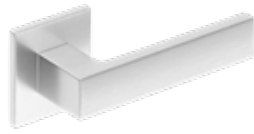

CUBE SLIM
brushed matte chrome



CUBE SLIM
glossy brass



CUBE SLIM
brass satin



CUBE SLIM
matte black



HANDLE CLASS
PREMIUM

escutcheon - keyhole profile
escutcheon - euro profile
escutcheon - bathroom



CUBE handle

Metal-Bud

PRODUCENT KLAMEK

glossy chrome, brushed matte chrome, brushed matte nickel, black matte

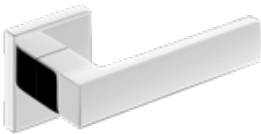

CUBE
glossy chrome



CUBE
brushed matte chrome



CUBE
brushed matte nickel



CUBE
matte black



HANDLE CLASS
PREMIUM

escutcheon - keyhole profile
escutcheon - euro profile
escutcheon - bathroom



CUBE PREMIUM handle

Metal-Bud

PRODUCENT KLAMEK

glossy chrome, brushed matte chrome, brushed matte nickel, black matte



CUBE PREMIUM
glossy chrome



CUBE PREMIUM
brushed matte chrome



CUBE PREMIUM
brushed matte nickel



CUBE PREMIUM
matte black



HANDLE CLASS
PREMIUM

escutcheon - keyhole profile
escutcheon - euro profile
escutcheon - bathroom





HANDLES FOR FLUSH AND PANELLED DOORS

NEW

OLIVIA R, LAURA R handles, classic escutcheon

glossy chrome, black matte, glossy brass

Metal-Bud

PRODUCENT KLAMEK



OLIVIA R
glossy chrome



OLIVIA R
matte black



OLIVIA R
glossy brass



LAURA R
glossy chrome



LAURA R
matte black



LAURA R
glossy brass



keyhole escutcheon, euro profile and toilet

NEW

JULIA R handle

glossy chrome, black matte, glossy brass

Metal-Bud

PRODUCENT KLAMEK



JULIA R
glossy chrome



JULIA R
matte black



JULIA R
glossy brass



keyhole escutcheon, euro profile and toilet

NEW

NOVA i JOWISZ handles

PVD matte brass, matte black

Metal-Bud

PRODUCENT KLAMEK



NOVA
PVD matte brass

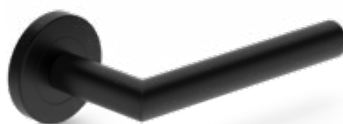

NOVA
matte black



JOWISZ
matte black

NEW



escutcheon – keyhole profile
escutcheon – euro profile
escutcheon – bathroom



escutcheon – keyhole profile
escutcheon – euro profile
escutcheon – bathroom



HANDLES FOR FLUSH AND PANELLED DOORS

NEW

RUMBA K FIT handle

Metal-Bud

PRODUCENT KLAMEK

matte brass



escutcheon – keyhole profile
 escutcheon – euro profile
 escutcheon – bathroom

RUMBA K FIT
 matte brass

NEW

LUNA SLIM PREMIUM SQUARE handle

Metal-Bud

PRODUCENT KLAMEK

glossy chrome, brushed matte chrome, glossy brass, black matte



LUNA SLIM square
 glossy chrome

LUNA SLIM square
 brushed matte chrome

LUNA SLIM square
 glossy brass

LUNA SLIM square
 matte black



HANDLE CLASS
PREMIUM

escutcheon – keyhole profile
 escutcheon – euro profile
 escutcheon – bathroom

NEW

BELLA SLIM ROUND, LUNA SLIM PREMIUM ROUND handles (prestigious escutcheon 6 mm thick)

Metal-Bud

PRODUCENT KLAMEK

glossy chrome, brushed matte chrome, glossy brass, satin brass, black matte



BELLA SLIM round
 glossy chrome

BELLA SLIM round
 brushed matte chrome

BELLA SLIM round
 glossy brass

BELLA SLIM round
 brass satin

BELLA SLIM round
 matte black



LUNA SLIM round
 glossy chrome

LUNA SLIM round
 brushed matte chrome

LUNA SLIM round
 glossy brass

LUNA SLIM round
 matte black

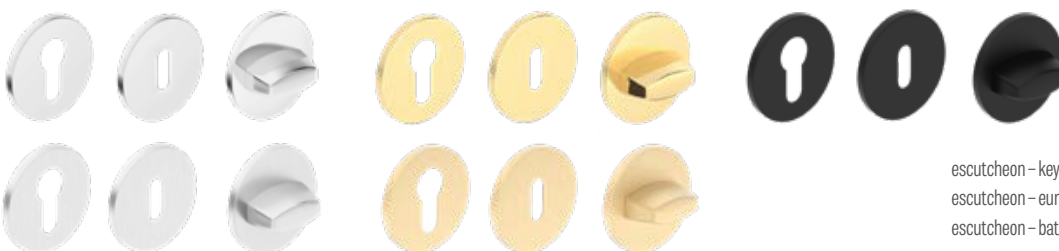

HANDLE CLASS
PREMIUM

escutcheon – keyhole profile
 escutcheon – euro profile
 escutcheon – bathroom



HANDLES FOR FLUSH AND PANELLED DOORS

DECO structural, IBIZA, LINEA, TREND handles

glossy chrome, nickel satin, graphite/chrome, white matte, black matte

Metal-Bud

PRODUCENT KLAMEK



DECO
facing layer: MEDIUM GREKO OAK



DECO
facing layer: BLACK



DECO
facing layer: WHITE GREKO



DECO
facing layer: GREKO SONOMA



DECO
facing layer: GREKO WALNUT



DECO
facing layer: GREKO OAK



IBIZA
glossy chrome



IBIZA
Graphite/chrome



IBIZA
nickel satin



IBIZA
white matte



IBIZA
matte black



LINEA
glossy chrome



LINEA
Graphite/chrome



LINEA
nickel satin



TREND
nickel satin



TREND
Graphite/chrome



TREND
glossy chrome

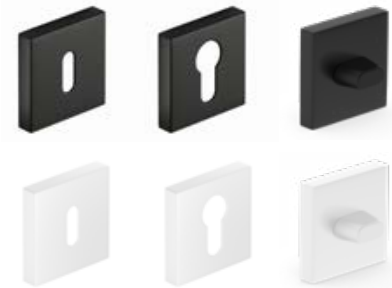

escutcheon - keyhole profile
escutcheon - euro profile
escutcheon - bathroom

HANDLES FOR FLUSH AND PANELLED DOORS

NEW

QUBIK, BARCELONA, RUMBA K handle

velvet nickel, glossy chrome, matte white, matte black, glossy brass, brushed nickel

Metal-Bud

PRODUCENT KLAMEK



QUBIK
velvet nickel



QUBIK
glossy chrome

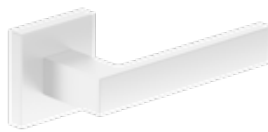

QUBIK
white matte



QUBIK
matte black

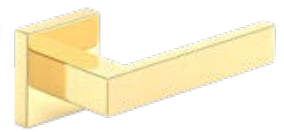

QUBIK
glossy brass



BARCELONA
velvet nickel



BARCELONA
glossy chrome



BARCELONA
matte black



BARCELONA
brushed nickel



RUMBA K
matte black

NEW

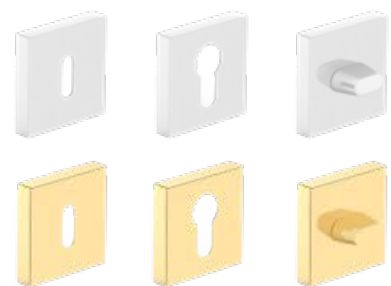
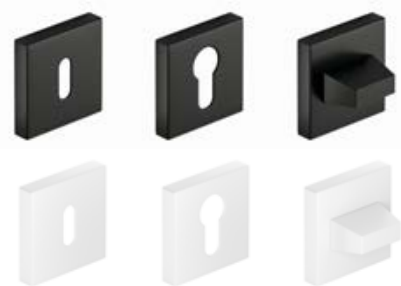
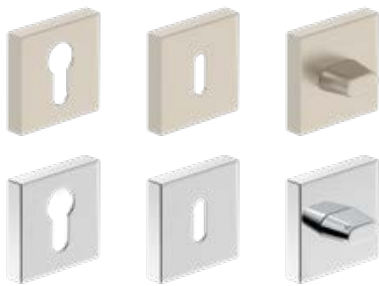

NEW

SCALA RT SLIM handle

nickel satin, brass satin, matte black

Metal-Bud

PRODUCENT KLAMEK



SCALA RT SLIM
nickel satin



SCALA RT SLIM
brass satin



SCALA RT SLIM
matte black



keyhole escutcheon, euro profile and toilet

NEW

ELEGANZA K FIT handle

matte black

Metal-Bud

PRODUCENT KLAMEK



ELEGANZA K FIT
matte black, gold insert



ELEGANZA K FIT
matte black, copper insert



escutcheon – keyhole profile
escutcheon – euro profile
escutcheon – bathroom



HANDLES FOR FLUSH AND PANELLED DOORS

NEW

MONDO handle

nickel satin

Metal-Bud

PRODUCENT KLAMEK



MONDO
nickel satin



escutcheon - euro profile



escutcheon - keyhole profile



escutcheon - bathroom

ERKADO handle

matte black

Metal-Bud

PRODUCENT KLAMEK



TOPAZ
matte black



escutcheon - euro profile



escutcheon - keyhole profile



escutcheon - bathroom

ERKADO handles

stainless steel

Metal-Bud

PRODUCENT KLAMEK



SAPPHIRE stainless steel



SUPRA round stainless steel



PROXIMA circular stainless steel

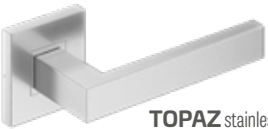

TOPAZ stainless steel



METRO stainless steel



PROXIMA square stainless steel



NOVA round stainless steel

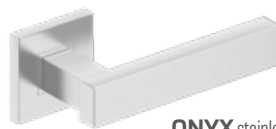

ONYX stainless steel



NOVA square stainless steel



JOWISZ stainless steel



ROMA stainless steel



escutcheon - euro profile, stainless steel



escutcheon - keyhole profile, stainless steel



escutcheon - bathroom, stainless steel



escutcheon - euro profile, stainless steel



escutcheon - keyhole profile, stainless steel



escutcheon - bathroom, stainless steel

HANDLES FOR FLUSH AND PANELED DOORS

NEW

CAMILA handles

satin chrome, matte black

Metal-Bud

PRODUCENT KLAMEK



NEW

CAMILA
chrome satin

keyhole profile escutcheon, euro profile and bathroom, chrome satin



NEW

CAMILA
matte black

keyhole escutcheon, euro profile and bathroom, black matte



HANDLES FOR FLUSH AND PANELED DOORS ON BACKPLATE

The handles on backplate are not used for non-rebated doors (see p. 149)

NEW

BLANKA, CAMILA, JULIA, LUNA backplate handles

satin chrome, shiny brass

Metal-Bud

PRODUCENT KLAMEK



BLANKA satin chrome
keyhole escutcheon, euro profile
latch, for bathroom



NEW

CAMILA satin chrome
keyhole escutcheon, euro profile
latch, for bathroom



JULIA shiny brass
keyhole escutcheon, euro profile
latch, for bathroom



LUNA shiny brass
keyhole escutcheon, euro profile
latch, escutcheon for bathroom

JOWISZ INOX backplate handles (10 mm thick escutcheon), 72 mm spacing

CERTIFIED FOR USE IN LEDA EI30 AND EI 60 FIRE AND FRONT DOORS

project stainless steel or black

Metal-Bud

PRODUCENT KLAMEK



JOWISZ INOX
escutcheon - keyhole profile
stainless steel
black



JOWISZ INOX
escutcheon - bathroom
stainless steel
black



JOWISZ INOX
escutcheon - euro profile
stainless steel
black



JOWISZ INOX
escutcheon, latch
stainless steel
black

TOPAZ INOX backplate handles (10 mm thick escutcheon), 72 mm spacing

stainless steel

Metal-Bud

PRODUCENT KLAMEK



TOPAZ INOX
escutcheon - keyhole profile



TOPAZ INOX
escutcheon - bathroom



TOPAZ INOX
escutcheon - euro profile



TOPAZ INOX
escutcheon, latch

HANDLES FOR FLUSH AND PANELLED DOORS ON BACKPLATE
The handles on backplate are not used for non-rebated doors (see p. 149)

ASTRA, SYDNEY and QUBIK backplate spacing 72 mm

Metal-Bud
PRODUCENT KLAMEK

nickel, patina, matte black

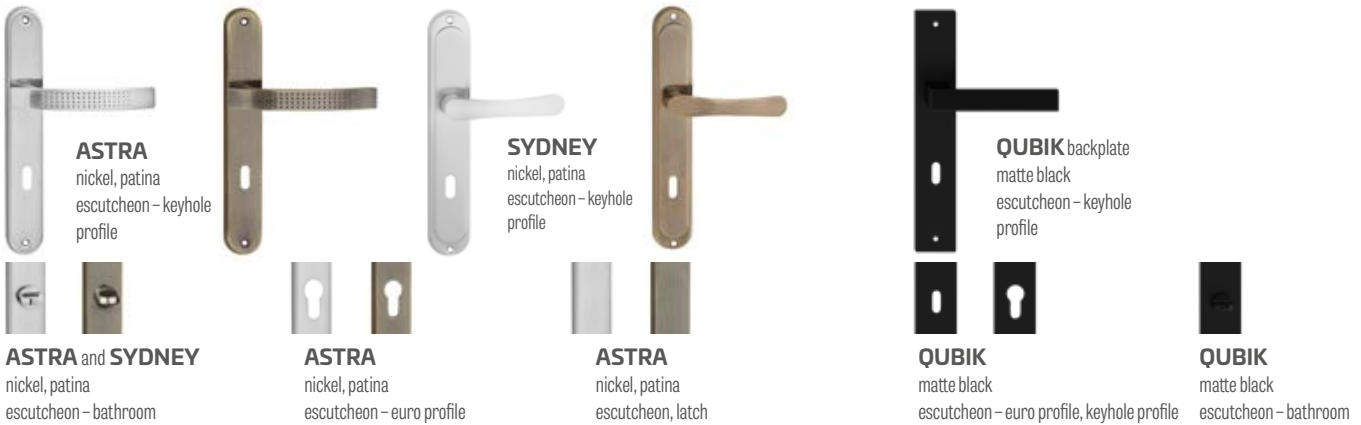

HANDLES FOR HERSE SET, HERSE LUX SET, HERSE MAX SET

ERKADO BONN and ESSEN¹⁾ handles (ESSEN – 10 mm thick escutcheon, BONN – 8 mm), spacing 72 mm
ERKADO SMART handle, spacing of 72 mm or 92 mm

Metal-Bud
PRODUCENT KLAMEK



CERTUS, CERTUS RC2 and RC3 handles

spacing of 72 mm for HERSE doors or 92 mm for FORTECA doors
escutcheon thickness: CERTUS – 9 mm/9 mm, RC2 – 12 mm/9 mm, RC3 – 15 mm/9 mm

Metal-Bud
PRODUCENT KLAMEK



¹⁾ ESSEN handles and escutcheons cannot be used with a multipoint lock

TECHNICAL INFORMATION

DOOR OPENING DIRECTIONS



Do you know how to distinguish between right and left-hand doors? This is a key decision for the comfort and functionality of your home. Here are some tips:

- Facing the door: position yourself so that the door opens towards you. If the hinges are on the left, it is the left-hand door; if on the right, it is the right-hand door.
- Space planning: avoid clashes with furniture and other doors.
- Functionality: bathroom doors always open outwards.

REBATED, NON-REBATED, REVERSE DOORS

OPENING DIRECTION



LOCK CORES



lock core
nickel satin



lock core with thumbturn
nickel satin

Lock cores in the master key system 30/45 + 30G/45
outswing doors – silver
– black

Lock cores in the master key system 30/45 + 30/45G
inswing doors – silver
– black

LOCK CORE	LOCK CORE WITH THUMBTURN
Size	Size
26/36	G30/40
30/30	G40/30
30/40	G30/50
30/45	G50/30
30/50	30/45G
20/40	30G/45

NOVA CLICK and TOPAZ CLICK HANDLES

LEFT
VERSION
L



RIGHT
VERSION
P

The LEFT version of the NOVA CLICK and TOPAZ CLICK handles is used for:
– right door outwards opening
– left door inwards opening

The RIGHT version of the NOVA CLICK and TOPAZ CLICK handles is used for:
– right door inwards opening
– left door outwards opening

DOOR FRAME JOINTS



HOW TO CALCULATE DOOR PRICE



DOUBLE DOORS



HOW TO SELECT A LOCK CORE

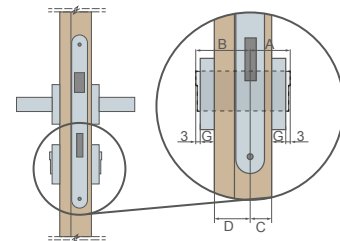

Example of calculating the lock core size for the flush and panelled doors (40mm) with the escutcheon thickness of G = 7 mm

$$A/B = (C+G+3) / (D+G+3)$$

$$A/B = (15+7+3) / (25+7+3)$$

$$A/B = 25/35$$

Door type	Door leaf thickness	Proportion of lock setting in door (C/D)	Recommended lock core size (A/B)*
flush, panelled (rebated)	40 mm	15/25	26/36
flush, panelled (non-rebated)	40 mm	20/20	30/30
reverse	40 mm	15/25	26/36
HERSE	46 mm	15/31	30/45
LEDA EI 30	50 mm	19/31	30/40
LEDA EI 60	60 mm	19/41	30/50
FORTECA RC2 & RC3	46 mm	20/26	30/40
LOFT (cassette)	39 mm	9/30	20/40

* Recommended lock core size for the escutcheon thickness of 7 mm and play of 2 mm to 4 mm



DOOR FACE FINISH TYPES

GREKO

The Greko laminate is also pre-impregnated, which means printing and then coating with paint with required properties. Using the performance finishing coats adds to the surface's resistance and flexibility of the product. The paint's silicon content ensures the film resistance is enhanced.

The Greko laminate is manufactured on a high density Japanese base layer which is not resin coated. This makes the film ecological, healthy and safe for people and environment both in the production process and during use, as well as for disposal. No formaldehyde or other harmful ingredients are used.

Its distinctive patterns are what distinguishes the Greko film. The facing layers bear striking resemblance to wood, as the high quality surface comes with a 3D natural wood effect. The facings look just like wood.

ST CPL, CPL 0.2 and CPL 0.7

The CPL facing is composed of a decorative layer impregnated in resins, and a base layer ensuring flexibility. Following the lamination process, the top resin layer is hardened for high resistance to scratching and abrasion. It is characterised by high resistance to impact, abrasion, scratching, heat and UV radiation

Thanks to using this type of material, the door can be installed in so-called "difficult" interiors [exposed to heat, moisture or extraordinary use]. Approx. laminate thickness: ST CPL – 0.15 mm, CPL 0.2 – 0.2 mm and CPL 0.7 – 0.7 mm. The CPL 0.7 laminate is used to cover only one leaf plane thanks to its unique hardness. The CPL 0,2 and CPL 0.7 laminated door leaves come with the leaf edge made of the so-called ABS, a highly durable PVC.

ST CPL facing in white, light grey, cappuccino, black has been refined in the AntiFinger coating limiting dirt and fingerprints. **NEW**

PREMIUM

The PREMIUM facing is a product based on Polypropylene (PP), a material of very high resistance to abrasion and scratching, plus top quality appearance. It adds a refined looks and individual character to the doors, as it imitates natural wood perfectly.

Not only does the PREMIUM facing attracts with its appearance but with its functionality, as it resists scratching better than average products and is fire-retardant and abrasion resistant. These properties ensure the extended longevity and maintenance-free use of the PREMIUM range products even in most adverse conditions.

UV VARNISH

The door surface has several coats of the TITANIUM WHITE UV modern UV hardened varnish. The flat surfaces are covered with a specialist base membrane in the first phase, and then coated twice with a top quality paint and hardened with UV.

The moulded surfaces cannot be covered with the membrane for technological reasons, so they are coated with three paint layers and hardened with UV.

The fully automatic coating process follows scanning to ensure ideal quality of the surface. Hardening the paint with the cutting-edge method involving UV light source ensures very high mechanical resistance.

EDGE FINISH TYPES

SOFT EDGE

SOFT  **NEW**

The SOFT door leaf comes with a chamfered edges, which lends an aesthetic and modern look to it. The leaf is finished with a laminate of an improved resistance to scratching, which dramatically enhances its resistance during use.



STANDARD EDGE

STANDARD 

It involves covering the flat plane with the 0.15 mm ST CPL, CPL 0.2, CPL 0.7 facings, polypropylene PREMIUM facing or GREKO laminate.

The door leaf made in STANDARD technology has unchamfered edges, which is where the face panel is joined with edges facing, as shown in the diagram. The laminate in the CPL 0.2 and CPL 0,7 laminates is made of very durable PVC, the so-called ABS. The joining method of the laminate is also identical for the non-rebated doors and non-rebated sliding systems.



AVAILABLE SOLUTIONS (pp. 154-165)

- wall-mounted sliding door systems, single door



- wall-mounted sliding door systems, double door



- pocket sliding door systems, single door



- pocket sliding door systems, double door

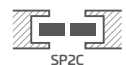

- supplementary system ZN1



- supplementary system ZN2



- double doors



¹⁾ applies only to BALDUR 1 WITH WHITE ST CPL facing layer with solid core infill

STILE PANELLED DOOR

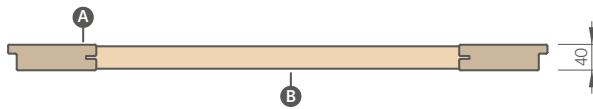
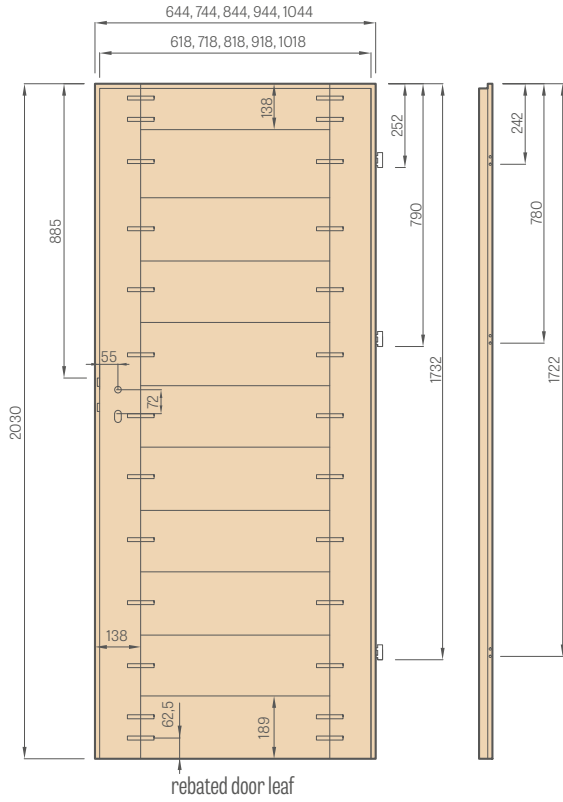

- A** MDF stiles
- B** MDF rails



Solid 35 mm or 22 mm thick rail



Aesthetic frameless tongue-and-groove glazing without bars



MDF stile for the GREKO, PREMIUM and CPL facings, also with the AntiFinger coating **NEW**



Glulam timber stile covered with HDF and MDF boards available for an additional charge for the following facing layers: WHITE PREMIUM, OAK NATUR PREMIUM, GRAPHITE ASH PREMIUM, GREY MAPLE PREMIUM, OAK ST CPL

FLUSH DOOR

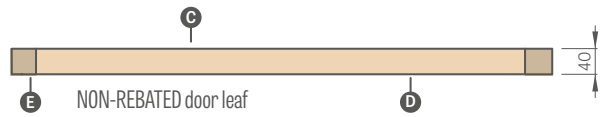
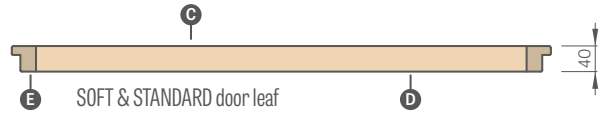
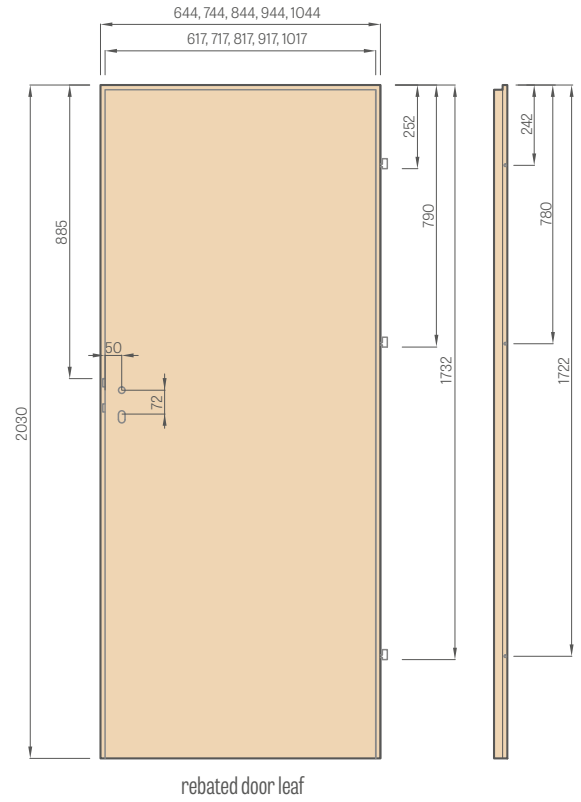

- A** - MDF board
- B** - gasket
- C** - HDF board
- D** - filling;
- E** - MDF or timber stiles in Herse SET and UNO PREMIUM

FILLING TYPES

honeycomb



solid core filling



The honeycomb and the solid core filling in the flush doors ONLY. For non-rebated and reversible panel door leaves with a solid panel filling and door leaves in sizes "100" and "110" we recommend (for an additional fee) an additional third hinge.

GRAF GLASS PANEL

standard hinge

vertical hinge

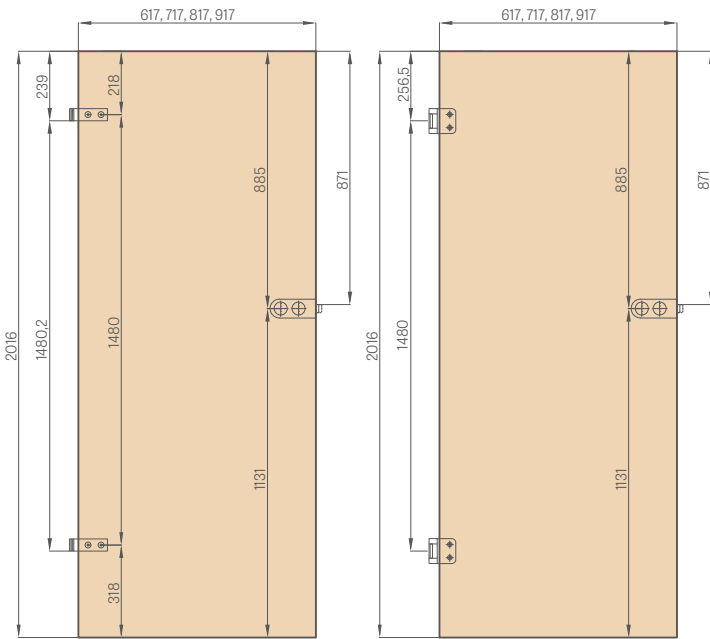

FIRE DOOR LEAF

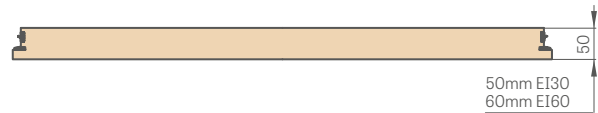
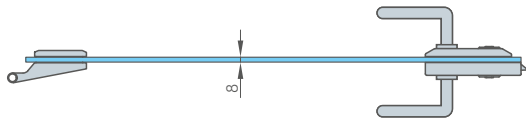
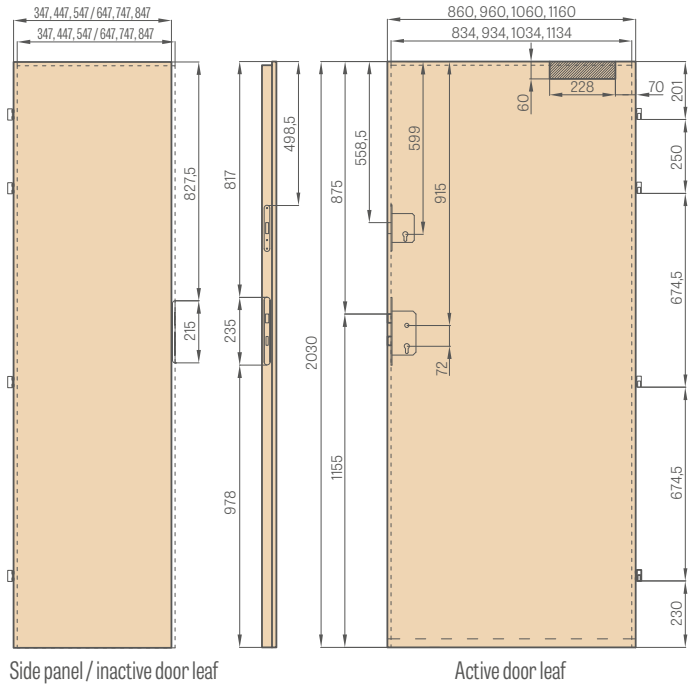

BATHROOM TURN & RELEASE

outside (Z)

inside (W)

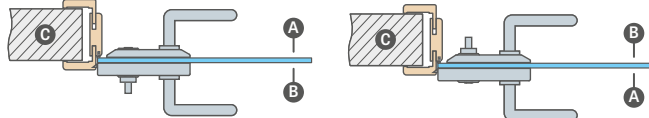

A corridor; **B** bathroom; **C** wall

Bathroom lock – for turn and release locks, select:

OUTSIDE lock – with the bathroom turn and release is fitted to the outside of the door (Z)

or

INSIDE lock – with the bathroom turn and release is fitted to the inside of the door (W)

NOTE: Directions for the turn and release locks apply (R/L)



Specially designed HALSPAN board filling
44 mm [EI30] / 54 mm [EI60]



Fire rated and smoke intumescent door gasket in red or black



Drop-down gasket with pressure adjustment by Allen key



Useful four hinges; Ø16, 3D adjustable



Fixed door frame

STANDARD OBLVERSE GLAZING



REVERSE GLAZING MADE TO ORDER:



G – plain side **M** – ornamental matte side

CLEANING, REVITALISATION & REGENERATION KIT FOR OTTIMO DOORS



CONCEALED MAGNETIC STOPS NEW



We assemble the magnetic door stop in a special place milled for this purpose on our own. Product delivered as a separate assortment.
 Caution (important information in case of underfloor heating): the floor element should be placed in the $\varnothing 14$ mm hole, 45 mm deep.
 Magnetic door stop not available for double-leaf doors.
 Available while supplies last.

METAL CAPS FOR HINGES



Brushed nickel, patina, glossy chrome, glossy brass, white matte and black matte

Available casings:
 - for Herse/FORTECA $\varnothing 16$, length 47 mm in colours: brushed nickel, patina, chrome gloss, brass gloss, white and black
 - for LEDA EI30 $\varnothing 16$ or LEDA EI60 $\varnothing 20$, length 64 mm in colours: matte chrome, black (no cover possible for doors with steel frame)
 - for interior leaves $\varnothing 15$, length 47 mm in colours: brushed nickel, patina, chrome gloss, brass gloss, white and black

VENTILATION



Square and round metal sleeves

Plastic woodgrain sleeves for STILE doors for GREKO, PREMIUM and CPL facing layers

Grilles

STANDARD RECUPERATION (height 24 mm) or MINI (height 14 mm)

Enhanced airflow trim - full-width leaves are shortened from the bottom by 15 mm or 5 mm (mini version). The door has a standard air gap between leaf and floor of approximately 9 mm, which together with the enhanced airflow trim gives an air gap of approximately 24 mm or 14 mm (mini version). Enhanced airflow trim is not available on bi-fold doors, non-rebated leaves for sliding systems and on FRAGI and GRAF models.

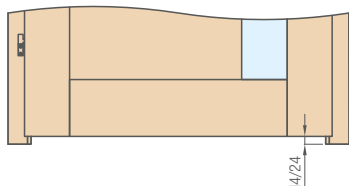

STANDARD VENTILATION (H. 32 mm) or MINI (height 15 mm)

Ventilation undercut not available on non-rebated leaves for sliding systems.

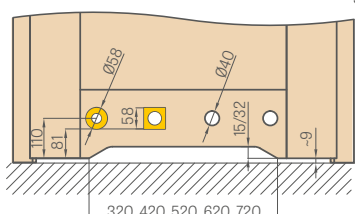

ELECTRIC DOOR STRIKE

(available for fixed and adjustable door frames for rebated and non-rebated doors, see p. 180-183 but unavailable for the door frames used with the GRAF glass panes and double doors)

Types of electric door strikes:

- basic 12 V
- basic 24 V
- switch operated 12 V
- switch operated 24 V
- reverse 12 V
- reverse 24 V



- BASIC** - normally closed, and opened when voltage is fed
- SWITCH OPERATED** - same operation as in the basic strike, but with an option to be switched off by moving the springbolt
- REVERSE** - closed when voltage is fed, opened when not

The reverse and switch operated electric door strikes unavailable for the fire doors

CUTTING THE DOOR LEAVES

Cutting the door leaves to size by customer acc. to Polish standard, up to 50 mm, or up to 80 mm for the HERSE SET door leaves (unless pre-cut), as well as in the flush doors, is possible if an additional lower rail has been fitted by the manufacturer.

(NOTE: cutting the door leaves to size by customer is not allowed for the FRAGI doors, double and fire doors, non-rebated leaves for sliding systems, glass GRAF doors, FORTECA RC2 and FORTECA RC3 burglar-proof doors, and panelled doors acc. to the CZ standard).

The door leaf height made acc. to the so-called CZ standard is lower than the PL standard by 47 mm.

Factory shortening of the door lowers the handle by the same height.

Leaf type	Handle height as per PL standard (measured from the bottom edge of the door) [mm]
STILE rebated panelled leaves	1107
STILE non-rebated panelled leaves	1110
rebated flush doors	1110
non-rebated flush doors	1110
reverse flush door	1110
Graf glass doors	1131
FORTECA RC2 & RC3 doors	1038
Herse, Herse Akustic doors	1107
Herse door with a strip lock	1033
Herse United door	1117
Leda EI30, EI60 door	1115

HARDWARE - LEVER TUMBLER LOCKS

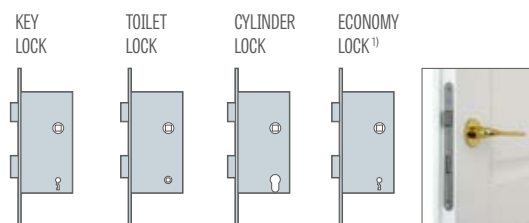

LOCK PZ CENTRES:

- The magnetic lock PZ centres:
 - for keys, toilet doors: 90 mm
 - for lock cores: 85 mm
 - (non-rebated door leaves with a magnetic lock and reversed swing doors)
- The latch and pin lock PZ centres:
 - for keys, toilet doors, lock core: 72 mm
 - (rebate door leaves and non-rebated door leaves with optional lever tumbler locks)

The toilet locks have a square-shaped bolt hole:

- acc. to PL standard: 4 mm
- acc. to CZ standard: 6 mm

¹⁾ lock provided without a keyhole in the leave



STANDARD "OBSERVE" GLAZING

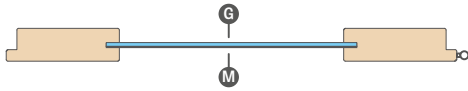

"REVERSE" GLAZING MADE TO ORDER

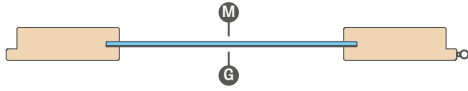

G plain side **M** matting side with decoration or colourless side with decoration

FROSTED and BLACK VSG 221, 331, 441 LAMINATED GLASS

for STILE doors and flush doors

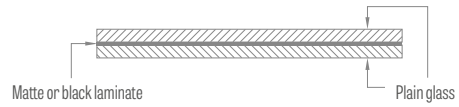

CLEARANCE UNDER DOOR LEAF AFTER INSTALLATION

Please check the lower clearance dimensions on all products prior to installation, as the allowable deviation due to frame dimensional tolerance is ± 3 mm

GLAZING TRANSLUCENCY ILLUSTRATION



GRAF 1
tempered,
painted glass



GRAF 12
tempered,
painted glass



GRAF 8
decormat



GRAF 9
transparent



GRAF 26
dark grey

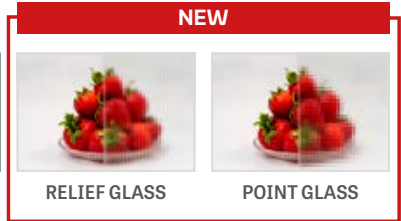

GRAF 29
laminated glass



GRAF 11 Decormat
graphite



Tempered glass
decormat frosted



VSG black or VSG/
ESG



VSG frosted or VSG/
ESG



GRAF 67
smoked graphite

FACTORY-DRILLED HANDLE OPENINGS



Factory-drilled handle opening in panelled doors for handles with separate escutcheons available from Erkado.

NON-REBATED & REVERSE HARDWARE



concealed hinge, silver



magnetic lock, silver



adjustable magnetic catch strike,
silver



concealed hinge, black



magnetic lock, black



adjustable magnetic catch strike,
black



concealed hinge, golden



magnetic lock, golden



adjustable magnetic catch strike,
golden

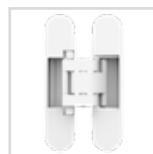

concealed hinge, white



magnetic lock, white



adjustable magnetic catch strike,
white

FRAME DOWELLING FOR NON-REBATED LEAVES

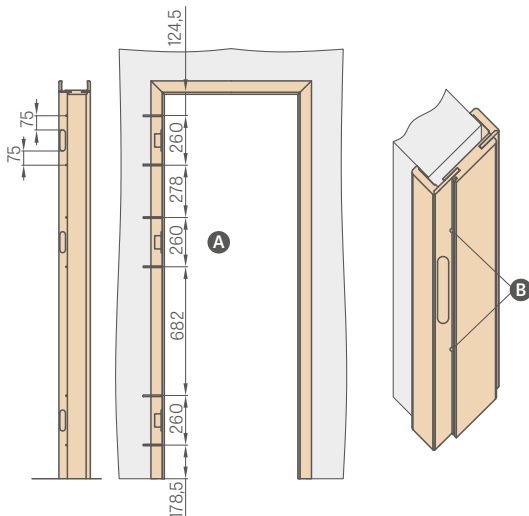

A Drill holes for metal screws of min length 80 mm x $\varnothing 6$ mm

B Apart from installation foam, mounting anchors are required when installing the door frame. Drill the holes for screws under the gasket so that it hides them.

CROSSHEADS AND PILASTERS

PEONIA 1 with GREY ST CPL facing layer, with CUBE PREMIUM handle, with decorative crosshead and pilasters

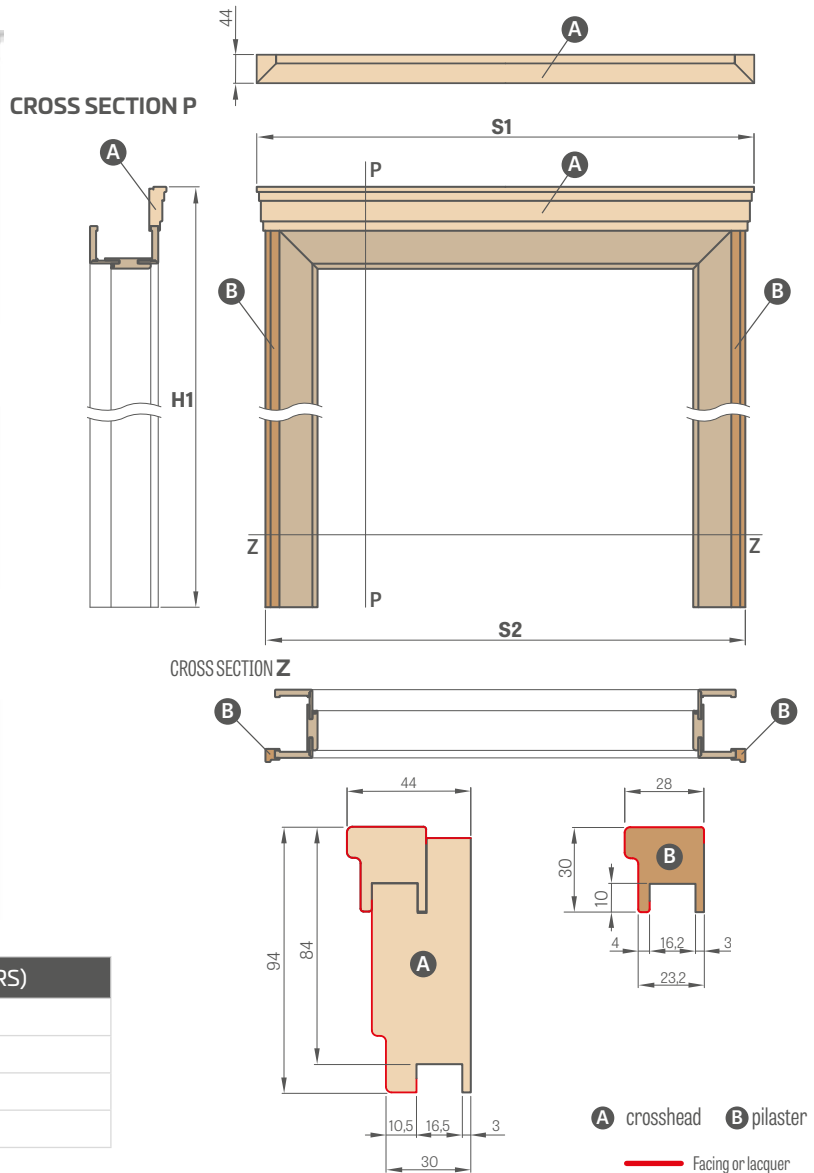

PRICE OF THE SET ¹⁾ (CROSSHEAD + PILASTERS)	
GREKO	
ST CPL & PREMIUM	
CPL 0.2 and CPL 0.7	
PAINTED	

¹⁾ the price is for a single-sided set; PL2112 standard – additional charge 15 %
Set for double-leaf doors – 30 % additional charge

Door width	DOOR FRAME and ADJUSTABLE REBATED TUNNEL		DOOR FRAME and ADJUSTABLE NON-REBATED TUNNEL		ADJUSTABLE REVERSE DOOR FRAME	
	S1	S2	S1	S2	S1	S2
"60"	838 ²⁾ /878 ³⁾	788 ²⁾ /828 ³⁾	863 ²⁾ /903 ³⁾	813 ²⁾ /853 ³⁾	883 ⁴⁾ /926 ⁵⁾	833 ⁴⁾ /876 ⁵⁾
"70"	938 ²⁾ /978 ³⁾	888 ²⁾ /928 ³⁾	963 ²⁾ /1003 ³⁾	913 ²⁾ /953 ³⁾	983 ⁴⁾ /1026 ⁵⁾	933 ⁴⁾ /976 ⁵⁾
"80N"	-	-	1039 ²⁾ /1079 ³⁾	989 ²⁾ /1029 ³⁾	1058 ⁴⁾ /1100 ⁵⁾	1008 ⁴⁾ /1050 ⁵⁾
"80"	1038 ²⁾ /1078 ³⁾	988 ²⁾ /1028 ³⁾	1063 ²⁾ /1103 ³⁾	1013 ²⁾ /1053 ³⁾	1083 ⁴⁾ /1126 ⁵⁾	1033 ⁴⁾ /1076 ⁵⁾
"90"	1138 ²⁾ /1178 ³⁾	1088 ²⁾ /1128 ³⁾	1163 ²⁾ /1203 ³⁾	1113 ²⁾ /1153 ³⁾	1183 ⁴⁾ /1226 ⁵⁾	1133 ⁴⁾ /1176 ⁵⁾
"100"	1238 ²⁾ /1278 ³⁾	1188 ²⁾ /1228 ³⁾	1263 ²⁾ /1303 ³⁾	1213 ²⁾ /1253 ³⁾	1283 ⁴⁾ /1326 ⁵⁾	1233 ⁴⁾ /1276 ⁵⁾
"110"	1338 ²⁾ /1378 ³⁾	1288 ²⁾ /1328 ³⁾	1363 ²⁾ /1403 ³⁾	1313 ²⁾ /1353 ³⁾	1383 ⁴⁾ /1426 ⁵⁾	1333 ⁴⁾ /1376 ⁵⁾

²⁾ square with architrave 6 cm, ³⁾ square with architrave 8 cm, ⁴⁾ reverse architrave, ⁵⁾ adjustable square RW

	H1					
	DOOR FRAME and ADJUSTABLE REBATED TUNNEL		DOOR FRAME and ADJUSTABLE NON-REBATED TUNNEL		ADJUSTABLE REVERSE DOOR FRAME	
	Square with architrave 6 cm	Square with architrave 8 cm	Square with architrave 6 cm	Square with architrave 8 cm	Reverse architrave	Adjustable square
PL STANDARD	2174	2194	2187	2207	2207	2229
PL 2112 STANDARD	2256	2276	2269	2289	-	-

NOTE: The working range of frame will be reduced by 3 mm (for single-sided use) or 6 mm (for double-sided use) when a set (crosshead + pilasters) for the rebated, non-rebated or reverse adjustable frame is selected. Example: assume a 140 mm thick wall with a single-sided set to be 143mm thick, while with a double-sided set to be 146 mm thick, and look for a corresponding masonry coverage in the table for rebated frames (p. 171), non-rebated frames (p. 168) or reverse frames (p. 167).

DOOR FRAME EXTENSION PANELS

WALL-MOUNTED

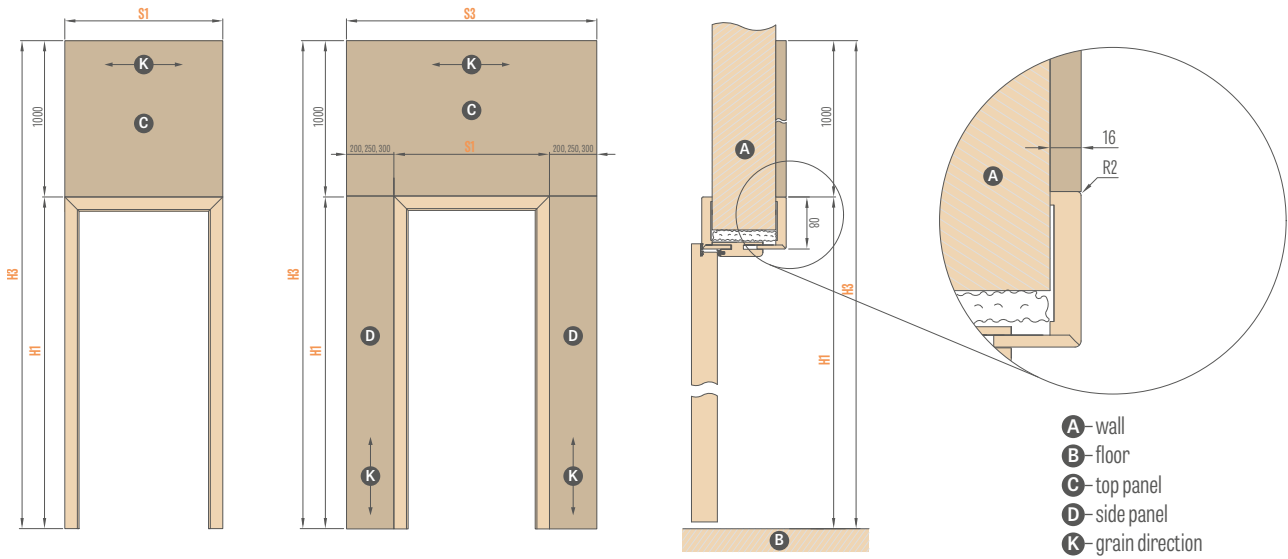

- A** – wall
- B** – floor
- C** – top panel
- D** – side panel
- K** – grain direction

INTERNAL DOORS ^{1) 3)}				
Frame type	H1	H3	Width	S1
Adjustable rebated door frame	2109	3109	"60"	786
			"70"	886
			"80"	986
			"90"	1086
			"100"	1186
Adjustable non-rebated door frame	2122	3122	"60"	811
			"70"	911
			"80N"	987
			"80"	1011
			"90"	1111
Reverse door frame (flush with the leaf)	2122	3122	"60"	791
			"70"	891
			"80N"	966
			"80"	991
			"90"	1091
Reverse door frame	2144	3144	"60"	834
			"70"	934
			"80N"	1010
			"80"	1034
			"90"	1134
			"100"	1234
			"110"	1334

TOP PANEL (1000 x S1) ¹⁾

FRONT DOORS ³⁾ (panels on the staircase side door opening inwards)										
Frame type	H1	H3	Width	S1	S3					
Adjustable HERSE door frame	2109	3109	"80"	986	1186	1236	1286	1386	1486	1586
			"90E"	1090	1290	1340	1390	1490	1590	1690
			"100"	1186	1386	1436	1486	1586	1686	1786
			"80N"	1012	1212	1262	1312	1412	1512	1612
HERSE fixed door frame "clip-on"	2142	3142	"80"	1052	1252	1302	1352	1452	1552	1652
			"90E"	1156	1356	1406	1456	1556	1656	1756
			"100"	1252	1452	1502	1552	1652	1762	1852
FORTECA fixed "clip-on" door frame	2147	3147	"80N"	1012	1212	1262	1312	1412	1512	1612
			"80"	1056	1256	1306	1356	1456	1556	1656
			"90E"	1156	1356	1406	1456	1556	1656	1756
			"100"	1256	1456	1506	1556	1656	1756	1856
FORTECA adjustable fixed frame (on the panels side)	2136	3136	"80N"	990	1190	1240	1290	1390	1490	1590
			"80"	1034	1234	1284	1334	1434	1534	1634
			"90E"	1134	1334	1384	1434	1534	1634	1734
LEDA fixed door frame "clip-on"	2147	3147	"80"	1085	1285	1335	1385	1485	1585	1685
			"90E"	1185	1385	1435	1485	1585	1685	1785
			"100"	1285	1485	1535	1585	1685	1785	1885
LEDA adjustable fixed frame (on the panels side)	2136	3136	"80"	1063	1263	1313	1363	1463	1563	1663
			"90E"	1163	1363	1413	1463	1563	1663	1763
			"100"	1263	1463	1513	1563	1663	1763	1863

PANEL 200	PANEL 250	PANEL 300	2 x PANEL 200	2 x PANEL 250	2 x PANEL 300
SINGLE-FACE SIDE PANEL			DOUBLE-FACE SIDE PANEL		

DOOR FRAME EXTENSION PANELS ²⁾ – price per m ²	
GREKO	
CPL0.2, ST CPL and PREMIUM	
PAINTED	

¹⁾ only top panels are available for interior door frames

²⁾ the panels shall be edged on all four edges in a colour similar to that of the panel surface. The area is calculated from the tables above.

³⁾ panels are only available for frame solutions with 8 cm architrave

INTEGRATED ONE-SIDE EXTENSION PANELS

MOUNTED INSTEAD OF AN ADJUSTABLE SQUARE OR WITH A CLIP

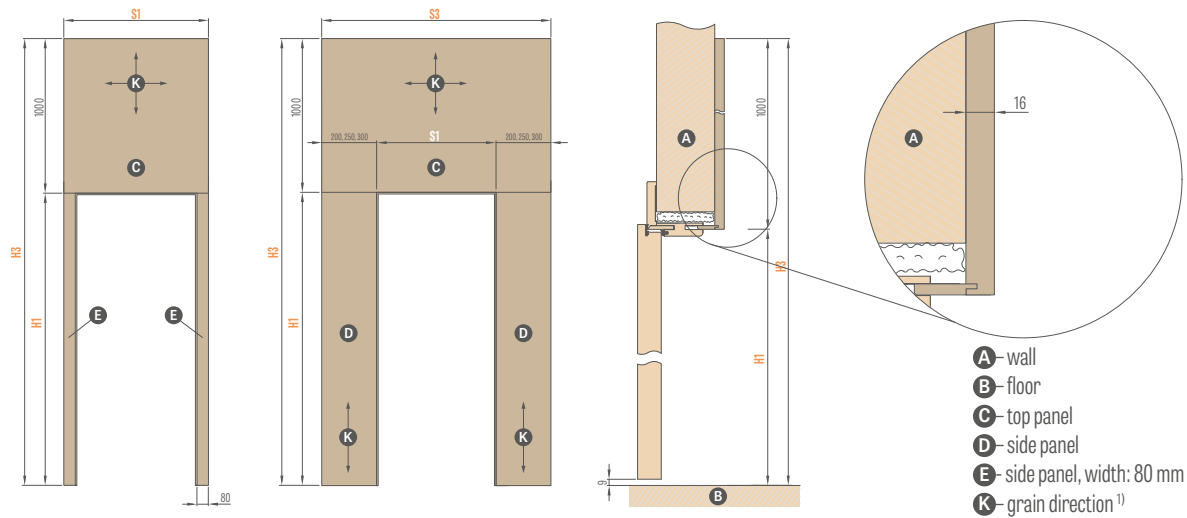

- A** – wall
- B** – floor
- C** – top panel
- D** – side panel
- E** – side panel, width: 80 mm
- K** – grain direction ¹⁾

INTERNAL DOORS ²⁾				
Frame type	H1	H3	Width	S1
Adjustable rebated door frame (adjustable square section side)	2029	3029	"60"	786
			"70"	886
			"80"	986
			"90"	1086
			"100"	1186
Adjustable non-rebated door frame (adjustable square section side)	2042	3042	"60"	811
			"70"	911
			"80N"	987
			"80"	1011
			"90"	1111
Reverse door frame (adjustable square side)	2064	3064	"60"	834
			"70"	934
			"80N"	1010
			"80"	1034
			"90"	1134
			"100"	1234
			"110"	1334
TOP PANEL (1000 x S1) ¹⁾				

FRONT DOOR (panels on the staircase side door opening inwards)										
Frame type	H1	H3	Width	S1	S3					
Adjustable HERSE door frame (adjustable square section side)	2029	3029	"80"	986	1106	1156	1206	1226	1326	1426
			"90E"	1090	1210	1260	1310	1330	1430	1530
			"100"	1186	1306	1356	1406	1426	1526	1626
HERSE fixed door frame "clip-on"	2062	3062	"80N"	1012	1132	1182	1232	1252	1352	1452
			"80"	1052	1172	1222	1272	1292	1392	1492
			"90E"	1156	1276	1326	1376	1396	1496	1596
FORTECA fixed "clip-on" door frame	2068	3068	"80N"	1012	1132	1182	1232	1252	1352	1452
			"80"	1056	1176	1226	1276	1296	1396	1496
			"90E"	1156	1276	1326	1376	1396	1496	1596
FORTECA adjustable fixed frame (on the panels side)	2057	3057	"80N"	990	1110	1160	1210	1230	1330	1430
			"80"	1034	1154	1204	1254	1274	1374	1474
			"90E"	1134	1254	1304	1354	1374	1474	1574
LEDA fixed door frame "clip-on"	2068	3068	"80"	1085	1205	1255	1305	1325	1425	1525
			"90E"	1185	1305	1355	1405	1425	1525	1625
			"100"	1285	1405	1455	1505	1525	1625	1725
LEDA adjustable fixed frame (on the panels side)	2057	3057	"110" ⁴⁾	1385 ⁴⁾	1505 ⁴⁾	1555 ⁴⁾	1605 ⁴⁾	1625 ⁴⁾	1725 ⁴⁾	1825 ⁴⁾
			"80"	1063	1183	1233	1283	1303	1403	1503
			"90E"	1163	1283	1333	1383	1403	1503	1603
			"100"	1263	1383	1433	1483	1503	1603	1703
			"110" ⁴⁾	1363 ⁴⁾	1483 ⁴⁾	1533 ⁴⁾	1583 ⁴⁾	1603 ⁴⁾	1703 ⁴⁾	1803 ⁴⁾
			PANEL 200	PANEL 250	PANEL 300	2x PANEL 200	2x PANEL 250	2x PANEL 300		
			SINGLE-FACE SIDE PANEL			DOUBLE-FACE SIDE PANEL				

DOOR FRAME EXTENSION PANELS ³⁾ – price per m ²	
GREKO	
CPLO.2, ST CPL and PREMIUM	
PAINTED	

¹⁾ The grain direction in the top panel up to a panel width of S1 ≤ 1050 mm can be chosen as horizontal or vertical, while above S1 > 1050 mm, as horizontal only

²⁾ only top panels are available for interior door frames

³⁾ the panels shall be edged on all four edges in a colour similar to that of the panel surface The area is calculated from the tables above.

⁴⁾ valid for LEDA doors only



SLIDING SYSTEMS

WALL-MOUNTED

WALL-MOUNTED SLIDING DOOR SYSTEM:

SINGLE SP1Nz (with bolt keeper)	
SINGLE SP1Nb (w/o bolt keeper)	
DOUBLE SP2N	

Price includes:

Aluminium track with a cover profile and door stop in the colour of the door leaf and length:

- 210 cm for "100" leaves
- 200 cm for "90" leaves
- 180 cm for "80" leaves
- 150 cm for "70" "60" leaves

Available wall-mounted sliding system sets

- track with a cover profile and door stop with gasket (only SP1Nz & SP1Nb)
- track with a cover profile and tunnel door frame (only for SP2N)
- track with a cover profile and door stop + tunnel door frame (only SP1Nz & SP1Nb)
- track with a cover profile and door stop with gasket + tunnel door frame (only SP1Nz & SP1Nb)

The SP1N and SP2N wall-mounted sliding door system with selected door leaves is also available as per the PL2112 standard.

The non-rebated door leaf for wall-mounted sliding system cannot have an air gap undercut.

The cover profile is neither laminated nor paint coated on the inside.

ADDITIONAL CHARGES

"tunnel" type adjustable door frame

included in the price of the adjustable frame

hook bolt lock with hardware²⁾

only for the single door system

oval, rectangular or round pull handle

glossy chrome, brushed matte chrome, glossy brass, black matte; two pcs. of pull handles per set

synchronisation

simultaneous opening and closing of the door leaves using only one leaf; only for SP2N

crossheads and pilasters

damper³⁾

automatic leaf damping during the final closing phase
only for SP1Nz and SP1Nb

standard 2112

additional charge for door leaves under standard 2112 and as the "tunnel" version + 15%

ROUND, OVAL AND RECTANGULAR PULL HANDLES¹⁾

glossy chrome, brushed matte chrome, glossy brass, black matte



¹⁾ in the BALDUR 8 model, the oval and square pull handles overlap the moulding

HOOK BOLT KEY LOCKS

glossy chrome, brushed matte chrome,
glossy brass
matte black

Key only in silver



The hook bolt key lock comes with two pull handles to choose

²⁾ NOTE: the height of the oval pull handle for the key / toilet door variant varies and is:
key: 1006 mm, toilet option: 1015 mm (measured from the bottom edge of the leaf)

³⁾ apply only on single side

WALL-MOUNTED SLIDING DOOR SYSTEM

WITH DOOR OPENING HOUSING

SP1Nz or SP1Nb (left, obverse version)

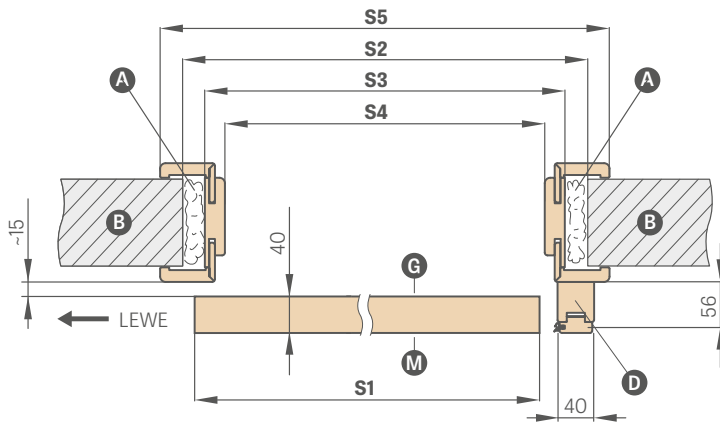

SP2N (obverse version)

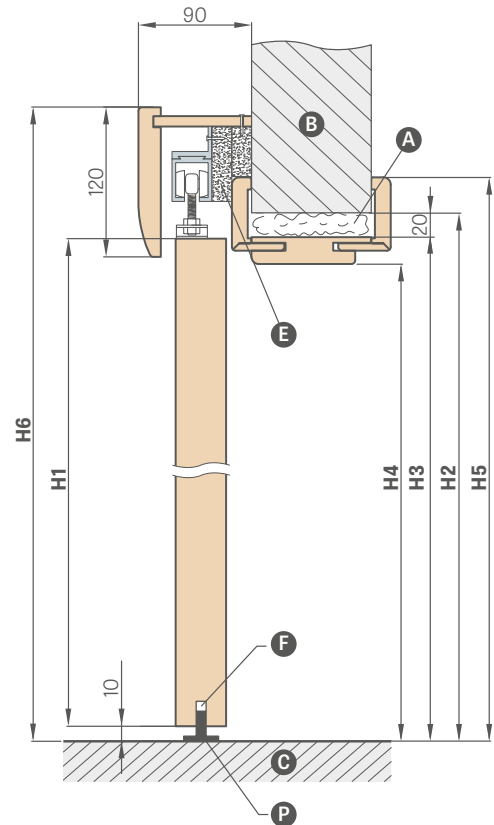
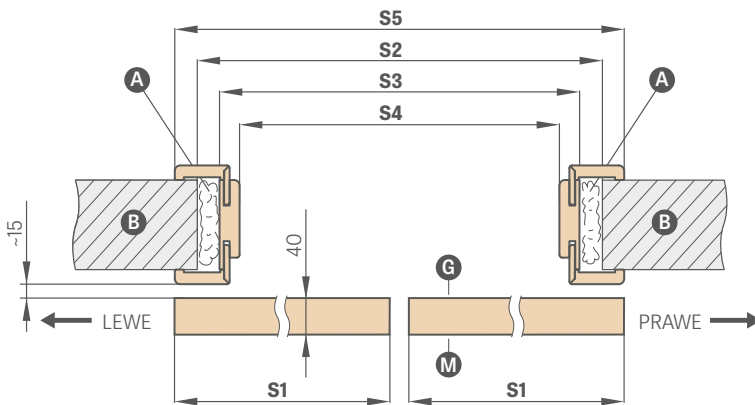

- A foam
- B wall
- C floor
- D door stop (directional as per the PL2112 standard)
- E spacer strip
- F milled groove for the guide rail
- G plain side of the glass
- P floor guide rail
- M glass matte side

WALL-MOUNTED SLIDING DOOR SYSTEM WITH DOOR OPENING HOUSING

		SINGLE DOORS					DOUBLE DOORS				
		"60"	"70"	"80"	"90"	"100"	"60" x 2	"70" x 2	"80" x 2	"90" x 2	"100" x 2
S1	door leaf width	644	744	844	944	1044	1288	1488	1688	1888	2088
S2	opening width in the wall	688	788	888	988	1088	1288	1488	1688	1888	2088
S3	frame outer width	648	748	848	948	1048	1248	1448	1648	1848	2048
S4	frame opening width	604	704	804	904	1004	1204	1404	1604	1804	2004
S4	opening width in the wall for SPN W/O HOUSING	604	704	804	904	1004	1204	1404	1604	1804	2004
S5	frame cover width architrave 6 cm /architrave 8 cm	746 / 786	846 / 886	946 / 986	1046 / 1086	1146 / 1186	1346 / 1386	1546 / 1586	1746 / 1786	1946 / 1986	2146 / NA
H1	door leaf height	2030 (2112) ¹⁾									
H2	opening height in the wall	2060 (2142) ¹⁾									
H2	opening height in the wall for SPN w/o housing	2020 (2102) ¹⁾									
H3	frame outer height	2040 (2122) ¹⁾									
H4	frame opening height	2018 (2100) ¹⁾									
H5	frame cover height architraves 6 cm /architraves 8 cm	2089 / 2109 (2171 / 2191) ¹⁾									2089 / none (2171 / 2191) ¹⁾
H6	overall system height	2142 (2224) ¹⁾									

¹⁾ PL2112 standard



WALL-MOUNTED SLIDING DOOR SYSTEM

LOFT STANDARD TYPE



BALDUR 7 leaf with TITANIUM WHITE UV facing layer, with black rectangular pull handle, with INDUSTRIAL door hanger

The LOFT STANDARD single sliding system is available with all leaves in the SP1N standard wall mounted sliding system.

Double sliding system LOFT STANDARD consists of two single door systems and a connecting element for rails.

Double LOFT STANDARD system is counted as 2 x single door system + connecting element for rails. Three door hangers to choose from: INDUSTRIAL, RETRO and ART (p. 157).

LOFT STANDARD sliding door system

oval, rectangular or round pull handle ³⁾

door closer on one side ⁵⁾

"100" door leaf

connector for tracks (enables the use of the LOFT system in the double door system)

Standard 2112 – additional charge for doors under Standard 2112

+ 15%

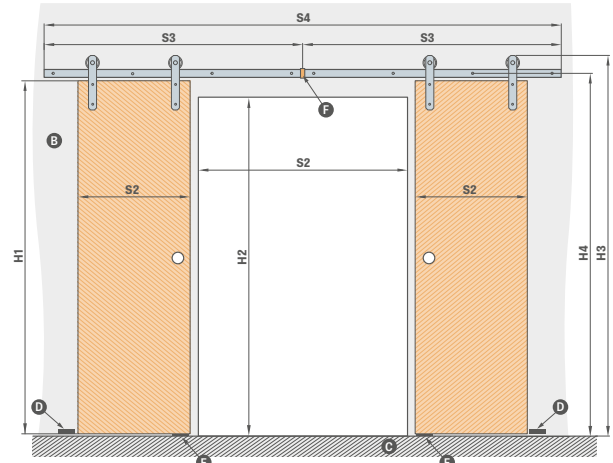
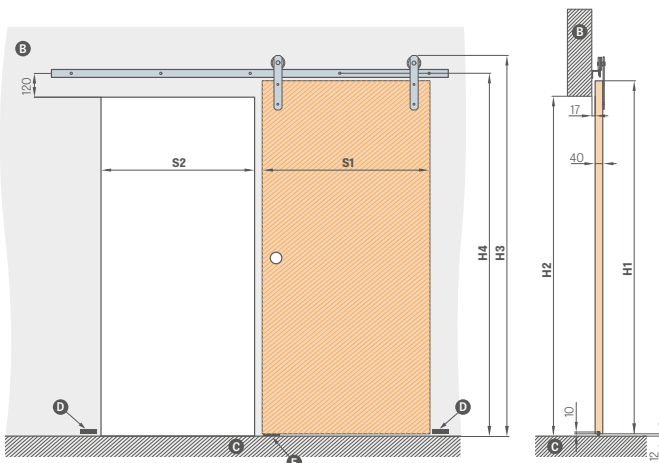

	"60"	"70"	"80"	"90"	"100"	
S1	door leaf width	644	744	844	944	1044
S2	opening width in the wall ¹⁾	574	674	774	874	974
H1	door leaf height	2030 (2112) ⁴⁾				
H2	opening height in the wall	1962 (2044) ⁴⁾				
H3	overall system height	2170 (2252) ⁴⁾				
H4	height to mounting holes in running rail	2082 (2164) ⁴⁾				

GUIDE RAIL FOR SINGLE DOOR SYSTEM LENGTH:

– 200 cm for "60" "70" "80" leaves

– 250 cm for "90" "100" leaves

	"120"	"140"	"160"	"180"	"200"	
S1	door leaf width	2 x 644	2 x 744	2 x 844	2 x 944	2 x 1044
S2	opening width in the wall ¹⁾	1202	1402	1602	1802	2002
S3	guide width	2000	2000	2000	2500	2500
S4	total guide width ²⁾	4000	4000	4000	5000	5000
H1	door leaf height	2030 (2112) ⁴⁾				
H2	opening height in the wall	1962 (2044) ⁴⁾				
H3	overall system height	2170 (2252) ⁴⁾				
H4	height to mounting holes in running rail	2082 (2164) ⁴⁾				

Ⓑ – wall Ⓒ – floor Ⓓ – wall mounted buffer

Ⓔ – guide Ⓕ – guide connector ²⁾

¹⁾ the leaf in the closed position overlaps 35 mm on each side

²⁾ a guide for double door system consists of two guides connected with a connector

³⁾ in the BALDUR 8 model, the oval and square pull handles overlap the moulding

⁴⁾ PL2112 standard

⁵⁾ used on one side for single system, on both sides for dual system

WALL-MOUNTED SLIDING DOOR SYSTEM

LOFT type



LOFT leaf with OAK ST CPL facing layer, with rounded pull handle, with RETRO door hangers

LOFT Type wall-mounted sliding door system is available in black and incorporates the LOFT Type solid core door leaf. The LOFT door leaf comes with a rigid honeycomb infill as standard or solid core panel for an additional charge. The door leaf features a non-rebated edge. The system is designed for clear finished opening, without a tunnel.

The complete system includes the sliding LOFT system + LOFT door leaf + pull handle + door closer on one or both side(s).

The LOFT double door system is counted as 2 x single door system + connecting rail element.

Three door hangers to choose from: INDUSTRIAL, RETRO and ART.

LOFT sliding door system

oval, rectangular or round pull handle

solid core filling

"100" door leaf

round and square metal ventilation sleeves (4 pieces); black matte

door closer on one side³⁾

connector for tracks (enables the use of the LOFT system in the double door system)

black door leaf edge finish

PREMIUM / CPL	CPL 0.2	TITANIUM WHITE UV PAINT



¹⁾ plain white facing imitating a painted surface

²⁾ special **AntiFinger** **NEW** coating to reduce dirt and fingerprints

³⁾ used on one side for single system, on both sides for dual system

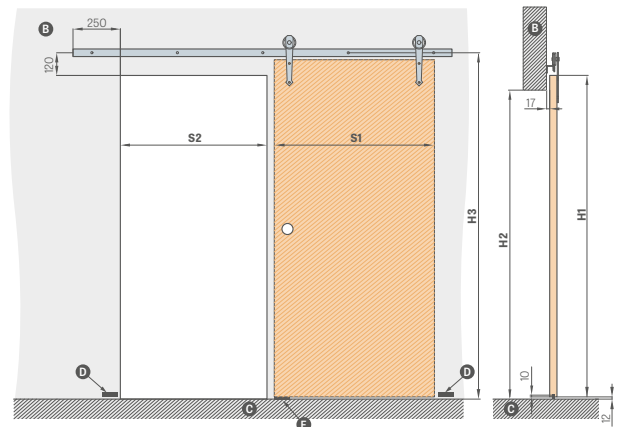

	"60"	"70"	"80"	"90"	"100"
S1 door leaf width	644	744	844	944	1044
S2 opening width in the wall	574	674	774	874	974
H1 door leaf height	2150	2150	2150	2150	2150
H2 opening height in the wall	2082	2082	2082	2082	2082
H3 height to mounting holes in running rail	2202	2202	2202	2202	2202

B- wall C- floor D- wall-mounted buffer E- guide

ROUND, OVAL, RECTANGULAR PULL HANDLES

glossy chrome, brushed matte chrome, glossy brass, black matte



GUIDE RAIL LENGTHS:

- 200 cm for "60" "70" "80" leaves

- 250 cm for "90" "100" leaves

DOOR HANGERS





WALL-MOUNTED SLIDING DOOR SYSTEM

MAGIC type



MAGIC door leaf with OAK PREMIUM facing layer, oval pull handle

MAGIC Type wall-mounted sliding door system incorporates the MAGIC Type solid core door leaf only. The MAGIC door leaf comes with a rigid honeycomb infill as standard or solid core panel for an additional charge. The door leaf features a non-rebated edge. The system is designed for clear finished opening, without a tunnel. The complete system includes the sliding MAGIC system + MAGIC door leaf + pull handle. The system is only available as a complete set (system + leaf).

MAGIC SLIDING DOOR SYSTEM

oval, rectangular or round pull handle

solid core filling

"100" door leaf

round and square metal sleeves (4 pcs);
glossy chrome, brushed matte chrome, black matte

black door leaf edge finish

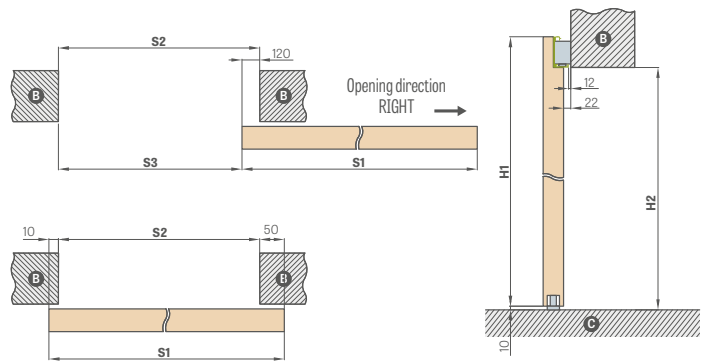

MAGIC WALL-MOUNTED SLIDING DOOR SYSTEM						
		"60"	"70"	"80"	"90"	"100"
S1	door leaf width	644	744	844	944	1044
S2	opening width in the wall	584	684	784	884	984
S3	clear opening	464	564	664	764	864
H1	door leaf height	2150	2150	2150	2150	2150
H2	opening height in the wall	2100	2100	2100	2100	2100

B - wall C - floor

MAGIC DOOR LEAF		
PREMIUM / CPL	CPL 0.2	TITANIUM WHITE UV PAINT

WENGE DARK ST CPL

BLACK ST CPL ¹⁾

ANTHRACITE ST CPL ¹⁾

ANTHRACITE SATIN CPL

OAK PREMIUM

GRAPHITE ASH PREMIUM

OAK ST CPL

DARK GREEN ST CPL ¹⁾

GREY ST CPL 2

WALNUT CLASSIC CPL

GREY MAPLE PREMIUM

WHITE PREMIUM ¹⁾ TITANIUM WHITE UV

GREY OAK ST CPL

NAVY BLUE ST CPL ¹⁾

WHITE ST CPL ¹⁾²⁾

OAK RETRO CPL

WHITE BARK PREMIUM

NATUR OAK PREMIUM

NEW

SAGE ST CPL ¹⁾

LIGHT GREY ST CPL ¹⁾

GREY CPL

OAK CLASSIC CPL

CONCRETE PREMIUM

NATUR OAK PREMIUM TRANSVERSE

STONE GRAY ST CPL ¹⁾

CAPPUCCINO ST CPL ¹⁾

WHITE CPL

WALNUT CLASSIC PREMIUM

NEW

ROUND, OVAL, RECTANGULAR PULL HANDLES

Glossy chrome, brushed matte chrome, glossy brass, black matte



¹⁾ plain white facing imitating a painted surface
²⁾ special AntiFinger **NEW** coating to reduce dirt and fingerprints

WALL-MOUNTED SLIDING DOOR SYSTEM

GRAF GLASS DOORS



GRAF 61 SYSTEM

Sliding system for glass doors with a silver anodised aluminium or back matte powder-painted cover.

This system is complete and designed for fitting in a clear finished opening, as the tunnel is not available. The system range includes all GRAF glass panes, see pp. 68-71 and go to our website: www.erkado.pl and the B2B panel.

The complete system includes: sliding SYSTEM GRAF + glass pane SYSTEM GRAF + pull handle + door closer on one side

GLASS DOOR SLIDING SYSTEM

- silver anode
- matte black

glass pane:

GRAF 8 SYSTEM

GRAF 9 SYSTEM

GRAF 11, 32, 33, 35, 36, 38, 39, 61, 62 SYSTEM

GRAF 65 VSG/ESG SYSTEM black opaque glass

GRAF 66 VSG/ESG SYSTEM frosted glass

double-sided round pull handle, stainless steel

double-sided round pull handle, stainless steel, black matte

double-sided round pull handle, anodised aluminium in stainless steel or black matte (powder-coated)

"90" glass pane additional charge

door closer

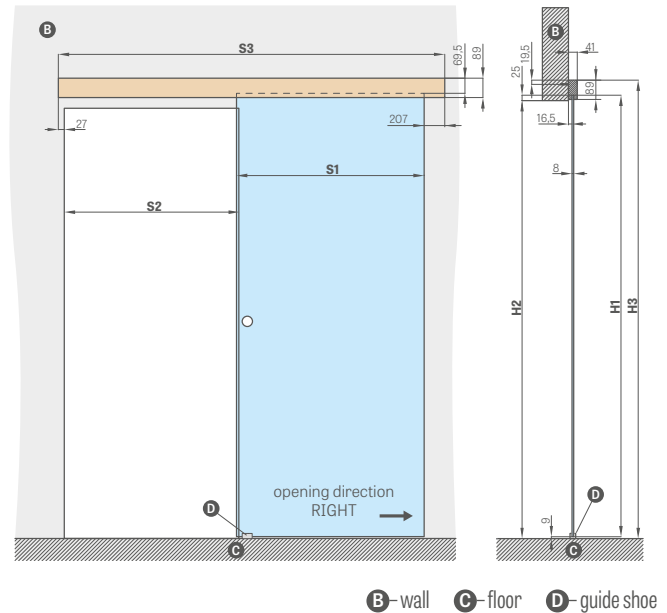

WALL-MOUNTED GLASS DOOR SLIDING SYSTEM					
		"60"	"70"	"80"	"90"
S1	door leaf width	662	762	862	962
S2	opening width in the wall	602	702	802	902
S3	guide rail length	1500	1500	1800	2000
H1	door leaf height	2036			
H2	opening height in the wall	max 2020			
H3	overall system height	2114			

PULL HANDLE



stainless steel, matte black
(outer diameter 54 mm)







anodised aluminium, stainless steel, black
matte, powder-coated
(outer diameter 65 mm)

SLIDING SYSTEMS

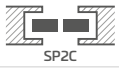
POCKET SYSTEMS

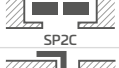
ERKADO pocket door system range includes:

BASIC TUNNEL INSTALLATION			GREKO / PREMIUM / ST CPL	TITANIUM WHITE UV
SP1C.100		single "100" pocket sliding system only available for STILE doors, painted doors and ALTAMURA 1, UNO PREMIUM and UNO LUX models		
SP2C.100		double "100" pocket sliding system only available for STILE doors and ALTAMURA 1 and UNO PREMIUM models		
SP1C.125		single "125" pocket sliding system		
SP2C.125		double "125" pocket sliding system		
ZN1		one-sided supplementary basic in-wall installation for SP1C.100 or SP1C.125 system	price depends on adjustment range (see next page)	
ZN2		one-sided supplementary basic in-wall installation for SP2C.100 or SP2C.125 system	price depends on adjustment range (see next page) + 30%	

Not available for CPL0.2 & CPL0.7 laminates

$$\text{SLIDING SYSTEM PRICE} = \text{DOOR LEAF PRICE} + \text{ALUMINIUM POCKET PRICE} + \text{BASIC TUNNEL INSTALLATION PRICE} + \text{OPTIONAL INSTALLATION PRICE ZN1 OR ZN2}$$

Standard single/double pocket sliding system includes:

- aluminium case [LEON] SP1
- aluminium case [LEON] SP2
- non-rebated door leaf / two non-rebated door leaves – price for standard door leaf / price for two door leaves
- basic tunnel installation (see table above)
- tunnel installation ZN1 or ZN 2 – see table on the next page

ROUND, OVAL AND RECTANGULAR PULL HANDLES ¹⁾

glossy chrome, brushed matte chrome, glossy brass, black matte



HOOK BOLT KEY LOCKS

glossy chrome, brushed matte chrome,
glossy brass
matte black

key only in silver



the hook bolt key lock comes with two pull handles to choose

ADDITIONAL CHARGES

frame joints at 90 degrees

hook bolt lock with hardware ²⁾

only available for: SP1C.100, SP1C.125

oval, rectangular or round pull handle

glossy chrome, brushed matte chrome, glossy brass, black matte
available for SP1C.100, SP2C.100, SP1C.125, SP2C.125
pull handle set includes two pcs.

finger pull

glossy chrome, brushed matte chrome, glossy brass, black matte

synchronisation

simultaneous opening and closing of the door leaves using only one leaf
only available for: SP2C.100, SP2C.125

crossheads and pilasters

damper ³⁾

automatic soft close in the final closing phase; available for SP1C.100, SP1C.125 only

standard 2112

additional charge for door leaves under standard 2112, pockets and housings

+ 15%

¹⁾ in the BALDUR 8 model, the oval and square pull handles overlap the moulding

²⁾ NOTE: the height of the oval pull handle for the key / toilet door variant varies and is:
key: 1006 mm, toilet option: 1015 mm (measured from the bottom edge of the leaf)

³⁾ apply only on single side

One-sided adjustment range for the basic wall min-max (mm)	IN-WALL INSTALLATION IN THE SINGLE DOOR SYSTEM FOR ONE SIDE ZN1		
	GREKO	PREMIUM & ST CPL	TITANIUM WHITE UV NEW
0-40; 40-60; 60-80;			
80-100; 100-120; 120-140			
140-160; 160-180; 180-200			
200-220; 220-240			
240-260; 260-280			
280-300; 300-320			
320-340; 340-360			

- the system of one-sided in-wall installation for double doors ZN2 + 30% extra of the prices in table above
- additional charge of 15% for Standard 2112

		SINGLE & DOUBLE POCKET SLIDING SYSTEMS									
		"60"	"70"	"80"	"90"	"100"	2 x "60"	2 x "70"	2 x "80"	2 x "90"	2 x "100"
S1	door leaf width	644	744	844	944	1044	1288	1488	1688	1888	2088
S2	frame opening width	604	704	804	904	1004	1204	1404	1604	1804	2004
S3	pocket width	1318	1518	1718	1918	2118	2538	2938	3338	3738	4138
S4	frame cover width architrave 6 cm / architrave 8 cm	746 / 786	846 / 886	946 / 986	1046 / 1086	1146 / 1186	1346 / 1386	1546 / 1586	1746 / 1786	1946 / 1986	2146 / NA
S5	opening width in the pocket	655	755	855	955	1055	1255	1455	1655	1855	2055
S6	opening width in the wall	1338	1538	1738	1938	2138	2558	2958	3358	3758	4158
H1	door leaf height	2030 (2112) ¹⁾									
H2	frame cover height architraves 6 cm/architraves 8 cm	2092 / 2112 (2174 / 2194) ¹⁾									2092 / none (2174 / none) ¹⁾
H3	pocket height	2115 (2197) ¹⁾									
H4	frame opening height	2021 (2103) ¹⁾									
H5	opening height in the wall	2125 (2207) ¹⁾									

¹⁾ PL2112 standard



photo: wall-mounted sliding system



photo: pocket sliding system



SINGLE AND DOUBLE DOOR SYSTEMS

POCKET SYSTEMS

SP1C.100 (left, AWERS obverse glazing)

fixed range of 100 mm

pocket thickness before gypsum board installation – 75 mm

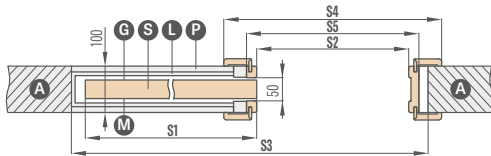

For UNO PREMIUM, ALTAMURA 1 only, and for all panelled doors.
The system does not come with dust brushes (not required).

SP1C.125 (left, AWERS obverse glazing)

fixed range of 125 mm

pocket thickness before gypsum board installation – 100 mm

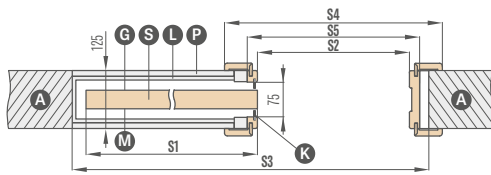

Only for use with flush doors which are supplied with a glass frame.
The system includes grey dust brushes.

ZN1 one-sided basic in-wall installation for SP1C.100 and SP1C.125

Basic in-wall installation range
from 0-40; 40-60; ... 340-360

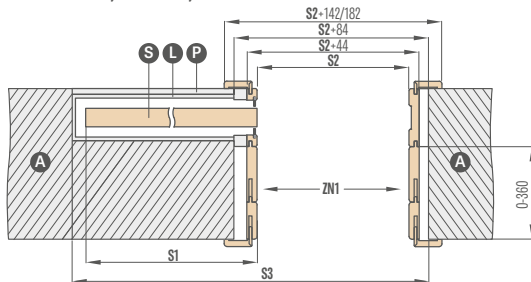

The drawing shows a one-sided basic in-wall installation ZN1.

SP2C.100 (AWERS obverse glazing)

fixed range of 100 mm

pocket thickness before gypsum board installation – 75 mm

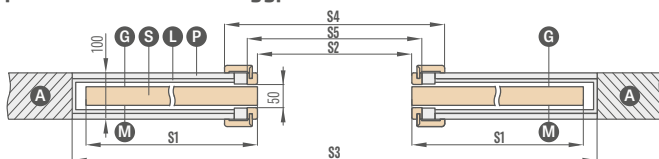

For UNO PREMIUM, ALTAMURA 1 only, and for all panelled doors.
The system does not come with dust brushes (not required).

SP2C.125 (AWERS obverse glazing)

fixed range of 125 mm

Pocket thickness before gypsum board installation – 100 mm

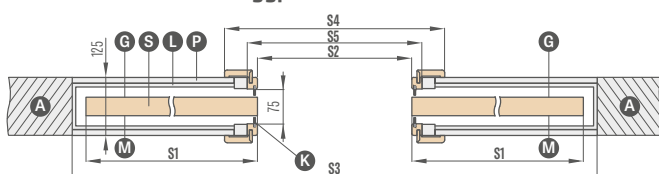

Only for use with flush doors which are supplied with a glass frame.
The system includes grey dust brushes.

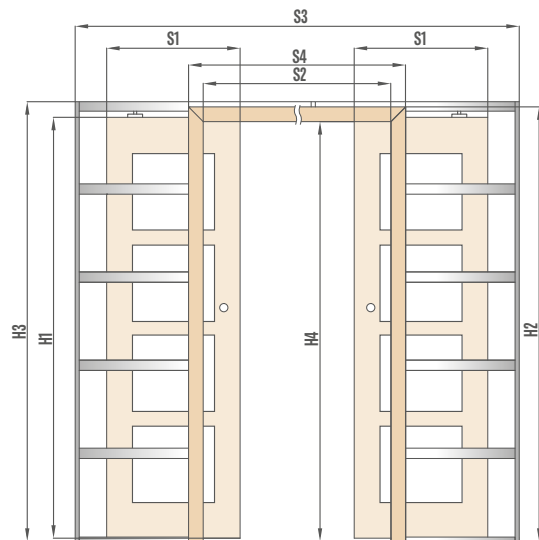
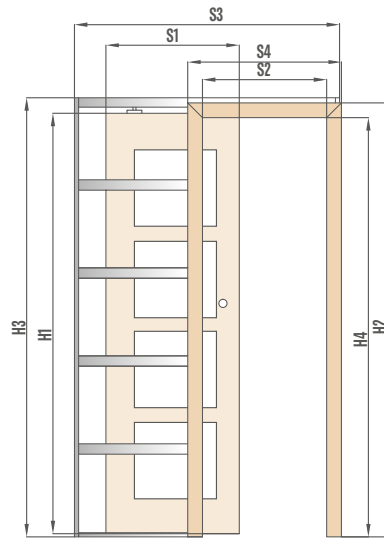

- A** – wall
- L** – aluminium case
- P** – gypsum board
- K** – dust brushes
- G** – plain plain side of the glass
- M** – glass matte side
- S** – door leaf

ZN2 one-sided basic in-wall installation for SP2C.100 and SP2C.125

basic in-wall installation range
from 0-40; 40-60; ... 340-360

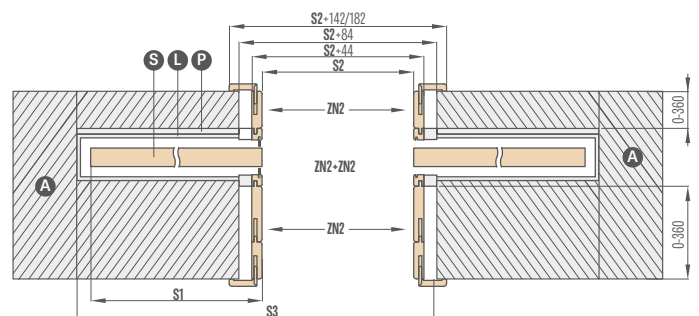

The drawing shows double-sided basic in-wall installation ZN2 + ZN2.

DOUBLE DOORS

REBATED AND NON-REBATED

USEFUL INFORMATION

DOUBLE DOORS



- The double doors are supplied with a solid core infill for an additional charge.
- The double doors are made according to available models of the flush single doors, STILE doors with respective features: colour, finish (STANDARD, SOFT), glazing etc.
- Double doors available in CPL 0.2 & CPL 0.7
- Passive doors use pull latches.
- Under "60" width passive door available as a solid core, plain version only – side panel (see drawing below).
- Side panels are made in the STANDARD edge flush technology. Available with a honeycomb infill as standard or solid core panel for an additional charge. Grain direction of the side panels is vertical.
- Both active and inactive door leaves come with lippings.
- Lippings in CPL 0.7 door leaves are laminated with CPL 0.2
- The double doors in non-rebated technology are available with a magnetic lock only.
- Double non-rebated leaf doors come with an adjustable door frame only.
- Electric door strike is not available for the double doors.
- PL2112 Standard for selected door leaves

AVAILABLE DOOR LEAF WIDTHS

- Flush and panelled DOUBLE DOORS from "120" to "190"*** and mixes with solid core, plain side panels

60 + 30*	70 + 30*	80 + 30*	90 + 30*	100 + 30*
60 + 40*	70 + 40*	80 + 40*	90 + 40*	100 + 40*
60 + 50*	70 + 50*	80 + 50*	90 + 50*	100 + 50*

* Side panel available in standard technology only as a solid core, plain version

** For "180" non-rebated doors

DOUBLE DOOR PRICE:

- Flush and panelled: active leaf **60 70 80 90 100** + passive leaf **60 70 80 90***

$$\text{Price of double-leaf doors with lipping} = \text{door leaf price} \times 2 + \text{lippings}$$

- Flush and panelled: active leaf **60 70 80 90 100** + solid core, plain passive side panels **30 40 50**

$$\text{price of double-leaf doors with side panel and lipping} = \text{door leaf price} + \text{full side panel with lippings}$$

- Prices of fixed and adjustable door frames for double doors + 30%
- Additional charge for solid core in the extension
- Painted side panel only with solid core TITANIUM WHITE UV – for an additional charge

* not in the non-rebated door leaves

DOUBLE DOORS

NON-REBATED

NON-REBATED DOUBLE LEAF DOOR WITH ADJUSTABLE DOOR FRAME

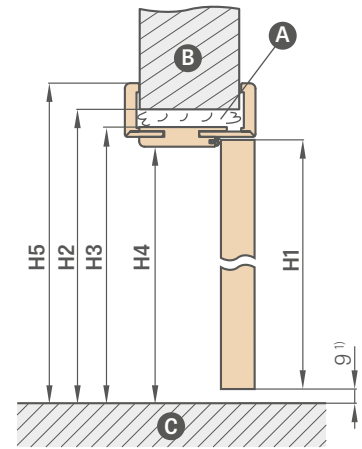
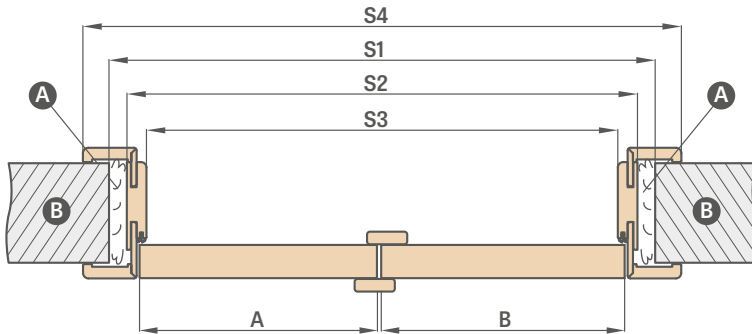

A – foam B – wall C – floor

¹⁾ allowable deviation due to frame dimensional tolerance of +- 3mm (we recommend to check before installation)

Adjustable door frame		NON-REBATED DOUBLE DOORS									
		"90"	"100"	"110"	"120"	"130"	"140"	"150"	"160"	"170"	"180"
A+B	door leaf width	988	1088	1188	1288	1388	1488	1588	1688	1788	1888
S1	opening width in the wall	1061	1161	1261	1361	1461	1561	1661	1761	1861	1961
S2	frame outer width	1021	1121	1221	1321	1421	1521	1621	1721	1821	1921
S3	frame opening width	977	1077	1177	1277	1377	1477	1577	1677	1777	1877
S4	frame cover width architrave 6 cm / architrave 8 cm	1119 / 1159	1219 / 1259	1319 / 1359	1419 / 1459	1519 / 1559	1619 / 1659	1719 / 1759	1819 / 1859	1919 / 1959	2019 / 2059
H1	door leaf height	2030 (2112) ²⁾									
H2	opening height in the wall	2073 (2155) ²⁾									
H3	frame outer height	2053 (2135) ²⁾									
H4	frame opening height	2031 (2113) ²⁾									
H5	frame cover height architraves 6 cm / architraves 8 cm	2102 / 2122 (2184 / 2204) ²⁾									

DOUBLE-LEAF DOORS
- SYMMETRIC



DOUBLE-LEAF DOORS
- ASYMMETRIC



DOUBLE-LEAF DOORS
- WITH PLAIN SIDE PANEL



²⁾ PL2112 standard

DOUBLE DOORS

REBATED

REBATED DOUBLE-LEAF DOORS WITH ADJUSTABLE DOOR FRAME

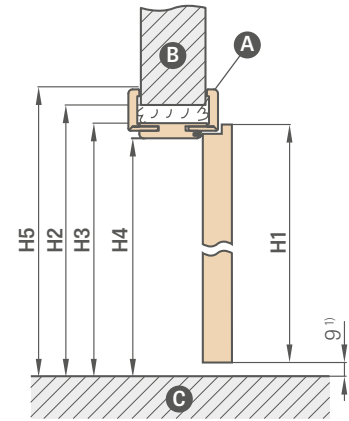
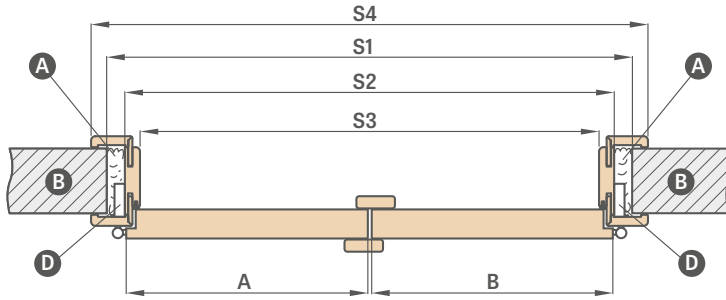

Ⓐ-foam Ⓑ-wall Ⓒ-floor Ⓓ-hinge socket

Adjustable door frame		DOUBLE DOORS										
		"90"	"100"	"110"	"120"	"130"	"140"	"150"	"160"	"170"	"180"	"190"
A+B	door leaf width	988	1088	1188	1288	1388	1488	1588	1688	1788	1888	1988
S1	opening width in the wall	1034	1134	1234	1334	1434	1534	1634	1734	1834	1934	2034
S2	frame outer width	994	1094	1194	1294	1394	1494	1594	1694	1794	1894	1994
S3	frame opening width	950	1050	1150	1250	1350	1450	1550	1650	1750	1850	1950
S4	frame cover width architrave 6 cm / architrave 8 cm	1092 / 1132	1192 / 1232	1292 / 1332	1392 / 1432	1492 / 1532	1592 / 1632	1692 / 1732	1792 / 1832	1892 / 1932	1992 / 2032	2092 / 2132
H1	door leaf height	2030 (2112) ²										
H2	opening height in the wall	2060 (2142) ²										
H3	frame outer height	2040 (2122) ²										
H4	frame opening height	2018 (2100) ²										
H5	frame cover height architrave 6 cm / architrave 8 cm	2089 / 2109 (2171 / 2191) ²										

REBATED DOUBLE-LEAF DOORS WITH FIXED DOOR FRAME

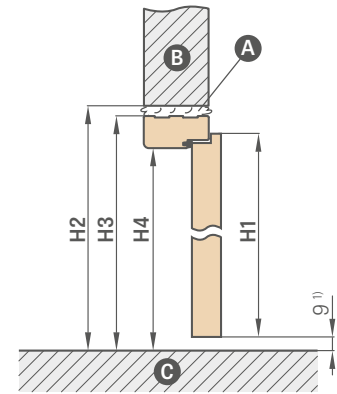
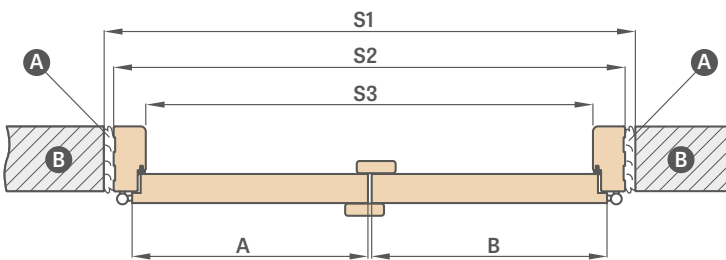

Ⓐ-foam Ⓑ-wall Ⓒ-floor

Fixed door frame		DOUBLE DOORS										
		"90"	"100"	"110"	"120"	"130"	"140"	"150"	"160"	"170"	"180"	"190"
A+B	door leaf width	988	1088	1188	1288	1388	1488	1588	1688	1788	1888	1988
S1	opening width in the wall	1068	1168	1268	1368	1468	1568	1668	1768	1868	1968	2068
S2	frame outer width	1038	1138	1238	1338	1438	1538	1638	1738	1838	1938	2038
S3	frame opening width	950	1050	1150	1250	1350	1450	1550	1650	1750	1850	1950
H1	door leaf height	2030	2030	2030	2030	2030	2030	2030	2030	2030	2030	2030
H2	opening height in the wall	2077	2077	2077	2077	2077	2077	2077	2077	2077	2077	2077
H3	frame outer height	2062	2062	2062	2062	2062	2062	2062	2062	2062	2062	2062
H4	frame opening height	2018	2018	2018	2018	2018	2018	2018	2018	2018	2018	2018

¹⁾ allowable deviation due to frame dimensional tolerance of +- 3mm (we recommend to check before installation)

²⁾ PL2112 standard

FOLDING DOORS



DESIGN

- the door leaf is composed of two parts joined with concealed hinges
- inner MDF stile covered with two HDF boards
- optionally for an additional charge internal timber stiles and top rail, MDF bottom rail, covered with two HDF boards
- honeycomb stabilising filling or solid core filling for an additional charge
- the door frame above 320 mm is composed of two parts, and above 400 mm, of three parts.

FINISH

- HDF board with a facing layer
- STANDARD leaf edge
- the door edge faced with edging in the same colour as the door leaf plane or optionally in black plain edging (black edging with horizontal grain for the TRANSVERSE NATUR OAK PREMIUM facing)

HARDWARE

- two hidden hinges between the wings, painted silver
- concealed guiding system in the top and bottom door sections
- a latch and pin lock, euro profile cylinder, economy lock or with a thumb turn

ADDITIONAL CHARGES

solid core filling

"100" door leaf

black door leaf edge finish

internal wooden stile (sides and top, bottom MDF)

extra charge for the third hinge

CPL 0.2 door leaf

CPL 0.7 door leaf

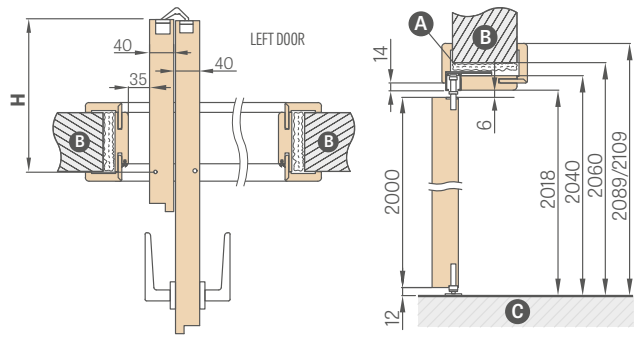
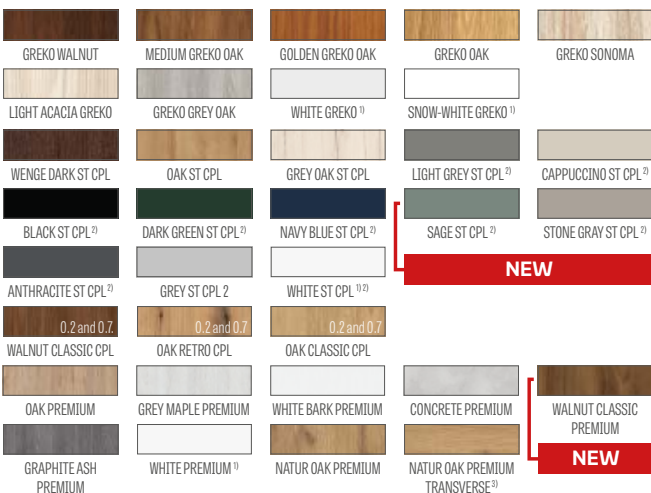

A-foam B-wall C-floor

Door width	A	B	C	E	F	G	H	I	J
"60"	641	614	604	648	688	746*/786**	152.5	218	418
"70"	741	714	704	748	788	846*/886**	202.5	268	468
"80"	841	814	804	848	888	946*/986**	252.5	318	518
"90"	941	914	904	948	988	1046*/1086**	302.5	368	568
"100"	1041	1014	1004	1048	1088	1146*/1186**	352.5	418	618

* architraves 6 cm / ** architraves 8 cm; joints at 45 degrees only

AVAILABLE DOOR LEAF WIDTHS

60 70 80 90 100



installation video
<https://youtu.be/tzccmzy/rvg>

Adjustment range min-max (mm)	Adjustment range min-max (mm)
80-100	240-260
100-120	260-280
120-140	280-300
140-160	300-340
160-180	340-360
180-200	360-380
200-220	380-400
220-240	400-420

Each 2 cm will be charged extra (based on the price range of 400-420 mm) until the range of 500-520 mm

¹⁾ plain white facing imitating a painted surface

²⁾ special **AntiFinger** coating to reduce dirt and fingerprints

³⁾ comes complete with the NATUR OAK PREMIUM door frame

COVERT CONCEALED DOOR SYSTEM

OPENING INWARDS AND OUTWARDS



DESIGN

- rebated or non-rebated door leaf
- inner MDF stile covered with two HDF boards
- optionally for an additional charge internal timber stiles and top rail, MDF bottom rail, covered with two HDF boards
- honeycomb stabilising filling or solid core filling for an additional charge

FINISH

- HDF board covered with PREMIUM, ST CPL facing, UV paint or a facing layer designed for subsequent paint coating or wallpapering
- door leaf edge made in rebated or non-rebated technology

HARDWARE

- two mortise hinges in the door frame (third optional, for an additional charge)
- magnetic lock in the rebated and non-rebated door leaf: with a key, thumb turn cylinder, economy or with a blockade

ADDITIONAL CHARGES

white or black door frame³⁾

painted door leaf; TITANIUM WHITE UV

solid core filling

additional bottom rail in the door leaf (can be trimmed by a customer up to max 8 cm)

round and square metal sleeves (4 pcs);
finish: brushed nickel, patina, white and black

plastic woodgrain sleeves (4 pcs)

standard or mini enhanced airflow trim, standard or mini ventilation undercut (page 149) or ventilation grille

third hinge

can be changed to a black magnetic catch in the leaf

can be changed to hinges and catch plate in black
– for two hinges or
– for three hinges

black door leaf edge finish

"100" door leaf

internal wooden stile (sides and top, bottom MDF)

drop down seal⁴⁾

LUX inlay; available versions pp. 96-103

magnetic stop (buffer)⁴⁾
(available in six colours p. 149) (while supplies last)

Standard 2112 – additional charge for door leaf and frame



AVAILABLE DOOR LEAF WIDTHS

60 70⁵⁾ 80⁵⁾ 90 100

¹⁾ plain white facing imitating a painted surface

²⁾ used for wallpaper hanging and painting

³⁾ aluminium colour frame as standard

⁴⁾ a stop will not allow a drop down seal, ventilation undercut and an door undercut to be used, and vice versa

⁵⁾ WHITE BASE leaves and aluminium door frame width "70" and "80" available on short lead times – ask your dealer for details

⁶⁾ special **AntiFinger** coating to reduce dirt and fingerprints



COVERT CONCEALED DOOR SYSTEM

INWARDS OPENING REBATED DOOR LEAF

STANDARD DIMENSIONS FOR INWARDS OPENING REBATED DOOR LEAVES

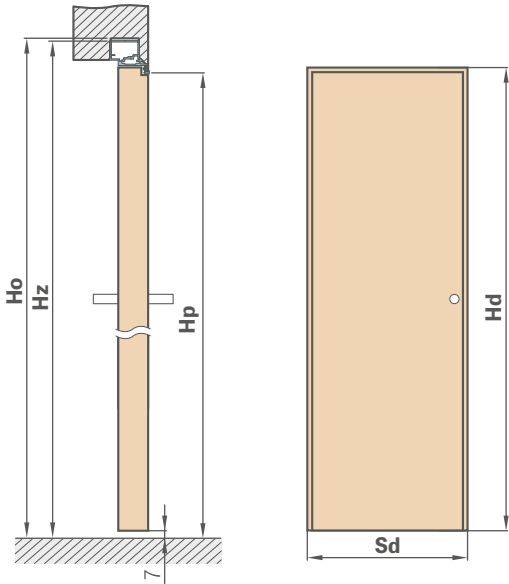

Door leaf width	Construction opening width	Frame outer width	Clear opening width
Sd [mm]	So [mm]	Sz [mm]	Sp [mm]
620	700	690	605
720	800	790	705
820	900	890	805
920	1000	990	905
1020	1100	1090	1005

Door leaf height	Construction opening height	Frame outer height	Clear opening height
Hd [mm]	Ho [mm]	Hz [mm]	Hp [mm]
2030 (2112) ¹⁾	2079 (2162) ¹⁾	2072 (2154) ¹⁾	2030 (2112) ¹⁾

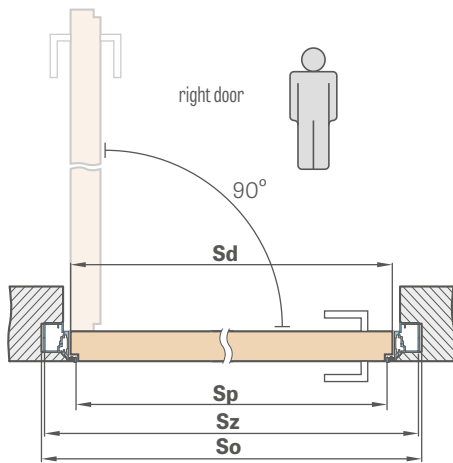

GYPSUM BOARD INSTALLATION

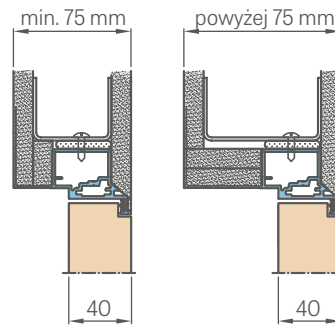

ALUMINIUM DOOR FRAME CROSS-SECTION

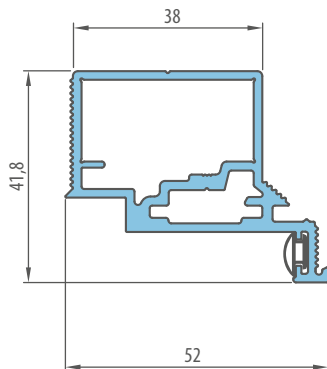

ENCLOSED IN WALL

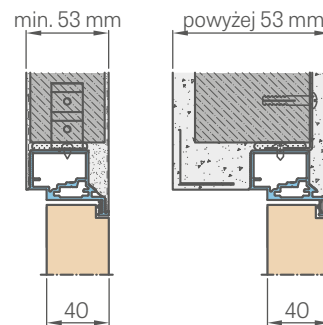

¹⁾ PL2112 standard

COVERT CONCEALED DOOR SYSTEM

OUTWARDS OPENING NON-REBATED DOOR LEAF

STANDARD DIMENSIONS FOR OUTWARDS OPENING NON-REBATED DOOR LEAVES

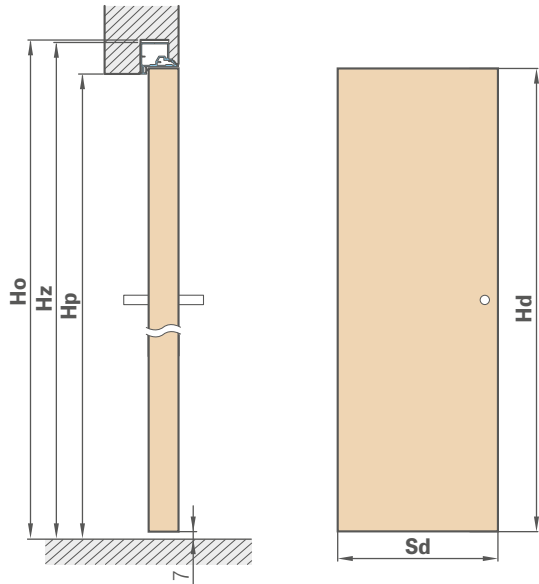

Door leaf width	Construction opening width	Frame outer width	Clear opening width
Sd [mm]	So [mm]	Sz [mm]	Sp [mm]
620	700	690	605
720	800	790	705
820	900	890	805
920	1000	990	905
1020	1100	1090	1005

Door leaf height	Construction opening height	Frame outer height	Clear opening height
Hd [mm]	Ho [mm]	Hz [mm]	Hp [mm]
2020 (2102) ¹⁾	2069 (2152) ¹⁾	2062 (2144) ¹⁾	2020 (2102) ¹⁾

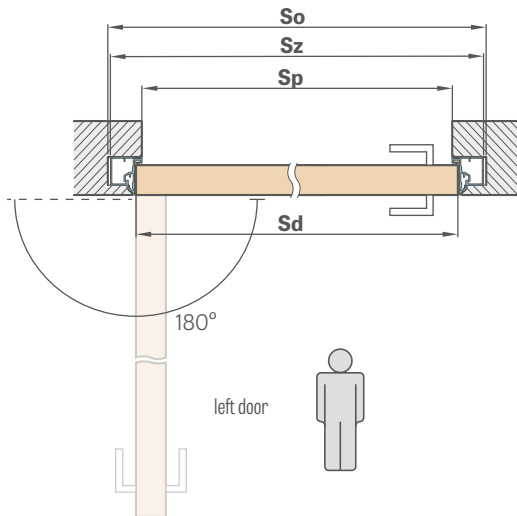

GYPNUM BOARD INSTALLATION

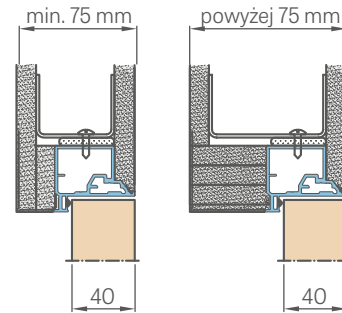

ALUMINIUM DOOR FRAME CROSS-SECTION

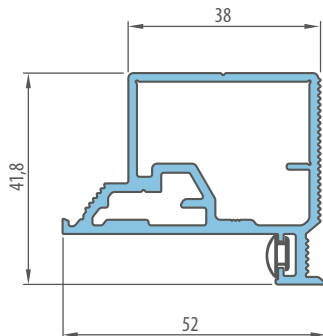

ENCLOSED IN WALL

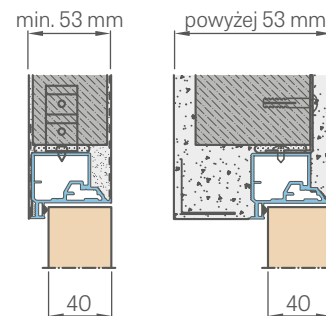

¹⁾ PL2112 standard

SIDELIGHTS FOR DOORS

REBATED

GENERAL INFORMATION

The sidelights for doors are preassembled and glazed with the VSG 331 safety glass in a frosted or clear variant. (Please state your choice of glass when placing orders). Additional components (e.g. wooden posts) may be required to integrate the side/top lights to the door, or more precisely to the adjustable or fixed frame, which the installer selects and supplies according to the existing opening conditions. ERKADO does not sell these items.

PRICE OF THE SIDELIGHTS FOR DOORS

SIDE LIGHT FOR REBATED SINGLE AND DOUBLE LEAF DOORS					
Height	Door frame	Width			
		"30"	"40"	"50"	"60"
Acc to PL standard	adjustable**				
	fixed				

CORNER LIGHT FOR REBATED SINGLE AND DOUBLE LEAF DOORS					
Height	Door frame	Width			
		"30"	"40"	"50"	"60"
"30"	adjustable**				
	fixed				
"40"	adjustable**				
	fixed				
"50"	adjustable**				
	fixed				
"60"	adjustable**				
	fixed				

TOP LIGHT FOR REBATED SINGLE LEAF DOORS						
Height	Door frame	Width				
		"60"	"70"	"80"	"90"	"100"
"30"	adjustable**					
	fixed					
"40"	adjustable**					
	fixed					
"50"	adjustable**					
	fixed					
"60"	adjustable**					
	fixed					

TOP LIGHT FOR REBATED DOUBLE LEAF DOORS												
Height	Door frame	Width										
		"90"	"100"	"110"	"120"	"130"	"140"	"150"	"160"	"170"	"180"	"190"
"30"	adjustable**											
	fixed											
"40"	adjustable**											
	fixed											
"50"	adjustable**											
	fixed											
"60"	adjustable**											
	fixed											

SIDELIGHTS FOR DOORS CATEGORIES

- FOR FIXED DOOR FRAMES
- FOR ADJUSTABLE DOOR FRAMES
- FOR SINGLE LEAF DOORS
- FOR DOUBLE-LEAF DOORS

AVAILABLE PRODUCT PACKAGES

REBATED SINGLE DOORS with top, side and corner lights

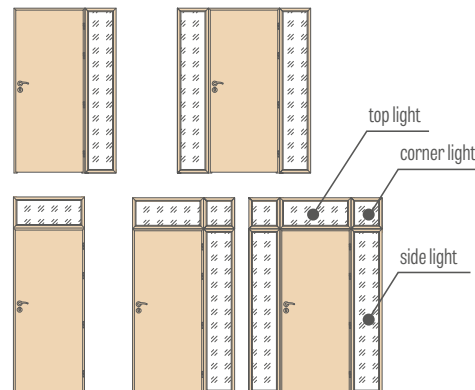

REBATED DOUBLE DOORS with top, side and corner lights

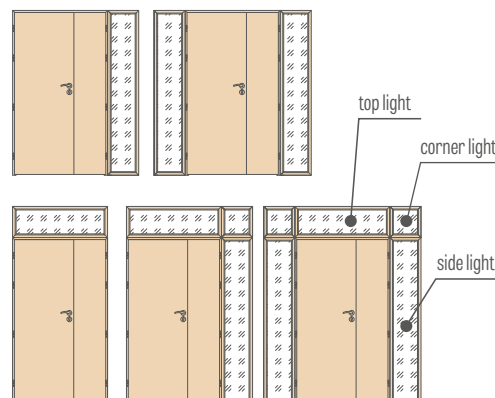

** Ranges available as for the standard adjustable rebated door frames, see p. 182-183.

The matte VSG 331 or clear VSG 331 safety glass is included and the price is the same for all facings and ranges for rebated door frames.

Prices apply to lights fitted on 6 and 8 cm architraves.

To paint coated lights + 50% additional charge applies.

Fitting strips for lights are fixed with headless pins which are seen as small dark spots once nailed (especially in white facings and paint coated lights).

Sidelight not available in CPL 0.2 and CPL 0.7 laminates.

Side lights
for rebated adjustable door frame
architrave 6 cm/architrave 8 cm

"30" **"40"** **"50"** **"60"**

446/486, 546/586, 646/686, 746/786

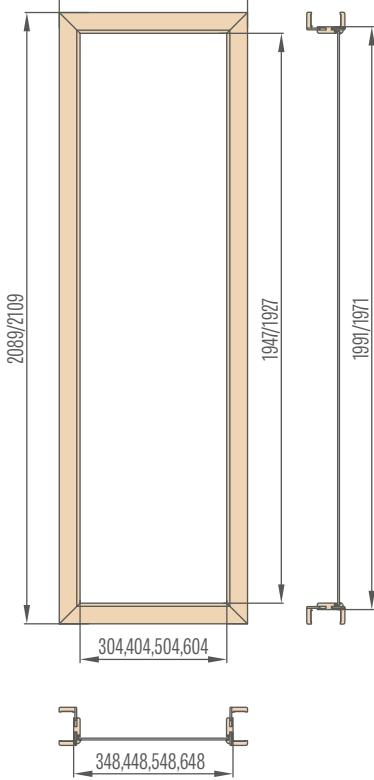

Corner lights
for rebated adjustable door frame
architrave 6 cm/architrave 8 cm

"30" **"40"** **"50"** **"60"**

446/486, 546/586, 646/686, 746/786

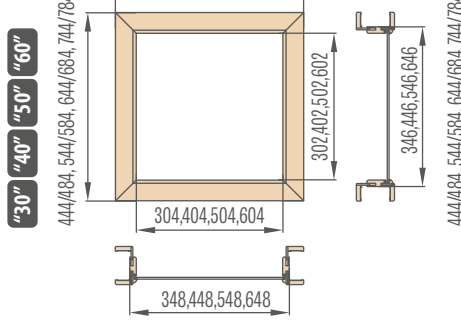

Top lights for rebated adjustable
door frame in single doors,
architrave 6 cm/architrave 8 cm

"60" **"70"** **"80"** **"90"** **"100"**

746/786, 846/886, 946/986, 1046/1086, 1146/1186

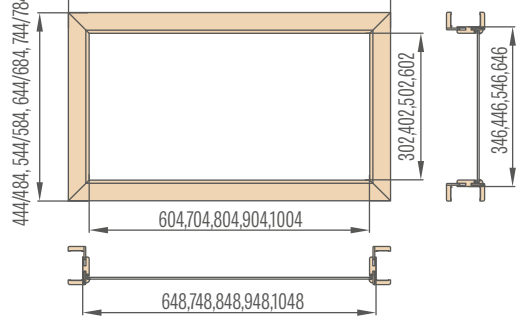

Top lights for adjustable door frame in rebated double doors architrave 6 cm / architrave 8 cm

"90" **"100"** **"110"** **"120"** **"130"** **"140"** **"150"** **"160"** **"170"** **"180"** **"190"**

1092/1132, 1192/1232, 1292/1332, 1392/1432, 1492/1532, 1592/1632,
1692/1732, 1792/1832, 1892/1932, 1992/2032, 2092/2132

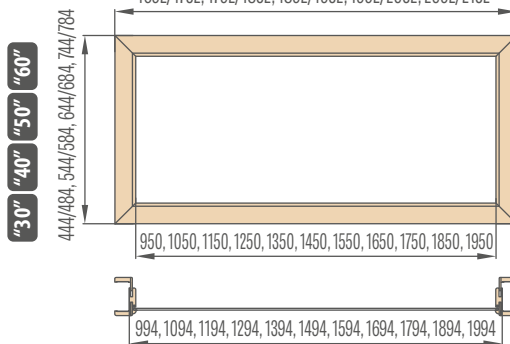

Calculation scheme for the wall opening height
for an adjustable frame:

- overall frame height
- + overall top light height
- 29 mm (for 60 mm angle bar) or 49 mm (for 80 mm angle bar)

Calculation scheme for the wall opening
width for an adjustable frame:

- overall door frame width
- + side light overall width
- 58 mm (for 60 mm angle bar) or 98 mm (for 80 mm angle bar)

Side lights for fixed door frame

"30" **"40"** **"50"** **"60"**

392,492,592,692

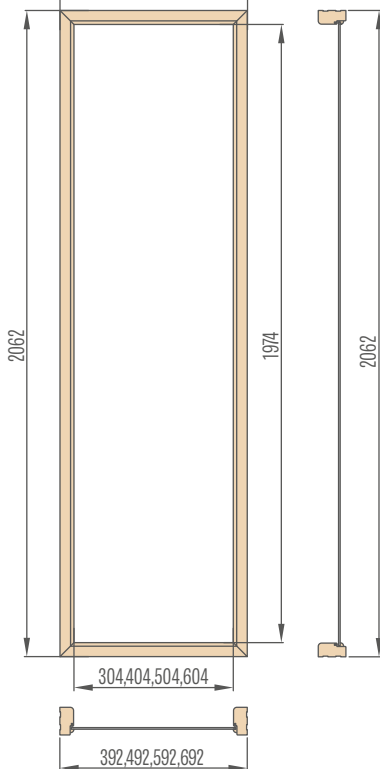

Corner lights for fixed door frame

"30" **"40"** **"50"** **"60"**

392,492,592,692

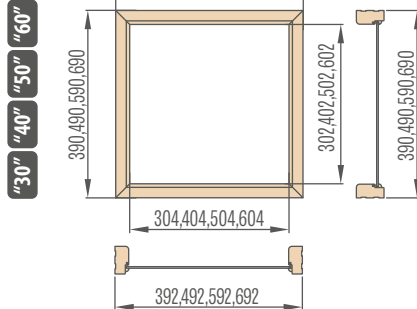

Top lights for fixed door frame in single leaf doors

"60" **"70"** **"80"** **"90"** **"100"**

692,792,892,992,1092

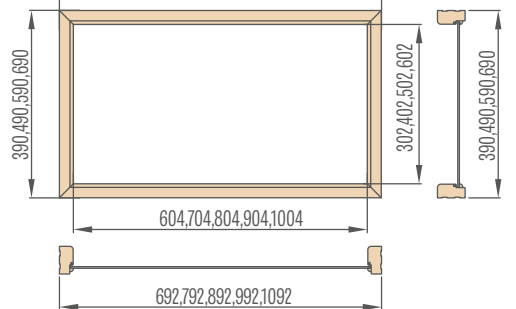

Top lights for fixed door frame in double doors

"90" **"100"** **"110"** **"120"** **"130"** **"140"** **"150"** **"160"** **"170"** **"180"** **"190"**

390,490,590,690

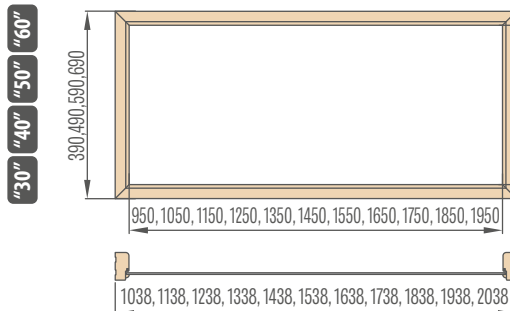



DOOR FRAMES

- The adjustable and fixed rebated door frames can be used for all types of ERKADO internal doors made in both flush and STILE panelled technologies.
- The adjustable non-rebated door frames can be used for internal doors made in both flush and STILE panelled technologies. These door frames are supplied with three concealed hinges.
- The door frame is made with high quality MDF board and covered with durable wood grain film or coated with durable UV paint.
- Depending on the technology, the door frames are faced with: GREKO, CPL, PREMIUM and UV paint.
- The frames for STILE doors have a third hinge as standard.
- Each adjustable or fixed door frame is complete with frame components (striker plate, hinge plate and top beam), hinges and mounting screws. The components are supplied with pre-drilled holes for fixing.
- Each set is enclosed with assembly manual and warranty certificate.
- The fixed door frame for Herse collection is rectangular and its core is made of glulam timber.

**ADJUSTABLE DOOR FRAME
REBATED DOOR LEAVES**



**ADJUSTABLE OVERLAY DOOR FRAME
FOR STEEL DOOR FRAMES**



**ADJUSTABLE DOOR FRAME
NON-REBATED DOOR LEAVES**



**STAND FIXED DOOR FRAME
REBATED DOOR LEAVES**



**STANDARD SQUARE FOR ADJUSTABLE
DOOR FRAME**

architrave 6 cm / architrave 8 cm

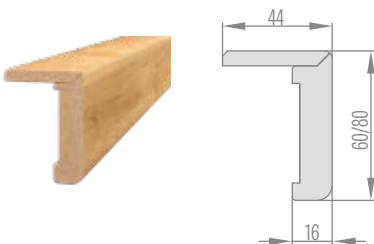

**SQUARE WITH EXTENDED TONGUE
FOR ADJUSTABLE DOOR FRAME**

architrave 6 cm / architrave 8 cm

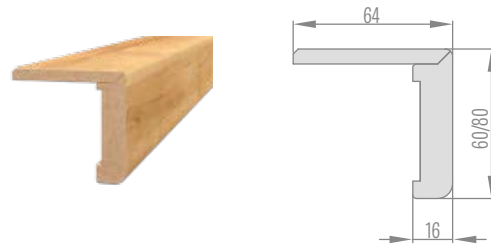

ADJUSTABLE REBATED DOOR FRAME

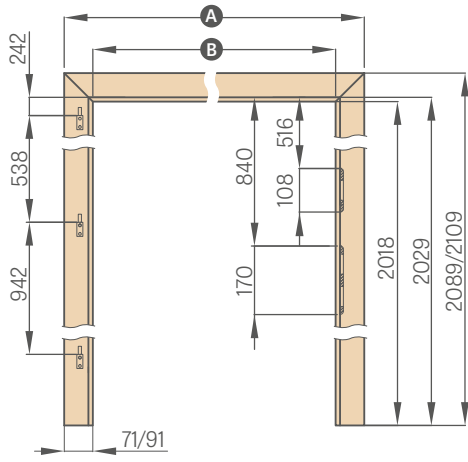

	"60"	"70"	"80"	"90"	"100"	"110"
A	746 / 786	846 / 886	946 / 986	1046 / 1086	1146 / 1186	1246 / 1286
B	604	704	804	904	1004	1104

architrave 6 cm / architrave 8 cm

ADJUSTABLE NON-REBATED DOOR FRAME - PL STANDARD

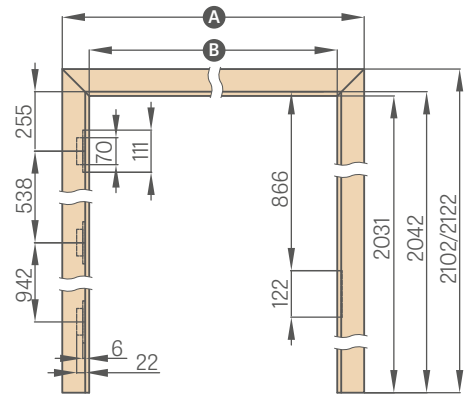

	"60N"	"60"	"70N"	"70"	"80N"	"80"
A	747/787	771 / 811	847/887	871/911	947/987	971/1011
B	605	629	705	729	805	829

	"90N"	"90"	"100"	"110"
A	1047/1087	1071 / 1111	1171 / 1211	1271/1311
B	905	929	1029	1129

Widths 60N, 70N, 90N available only for ALTAMURA 1, BALDUR 1 and UNO PREMIUM models

ADJUSTABLE REBATED DOOR FRAME - PL2112 STANDARD

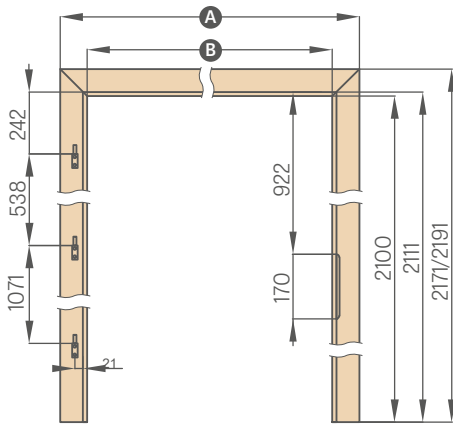

	"60"	"70"	"80"	"90"	"100"	"110"
A	746 / 786	846 / 886	946 / 986	1046 / 1086	1146 / 1186	1246 / 1286
B	604	704	804	904	1004	1104

ADJUSTABLE NON-REBATED DOOR FRAME - PL2112 STANDARD

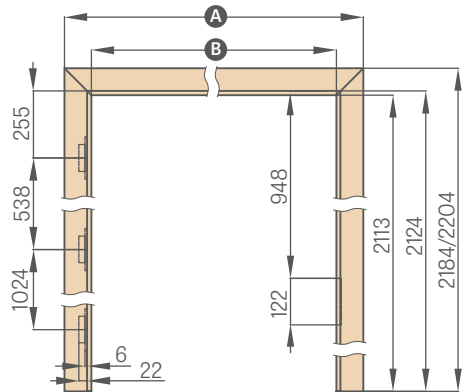

	"60"	"70"	"80N"	"80"	"90"	"100"	"110"
A	771 / 811	871/911	947/987	971/1011	1071 / 1111	1171 / 1211	1271/1311
B	629	729	805	829	929	1029	1129

ADJUSTABLE REBATED DOOR FRAME, TUNNEL TYPE

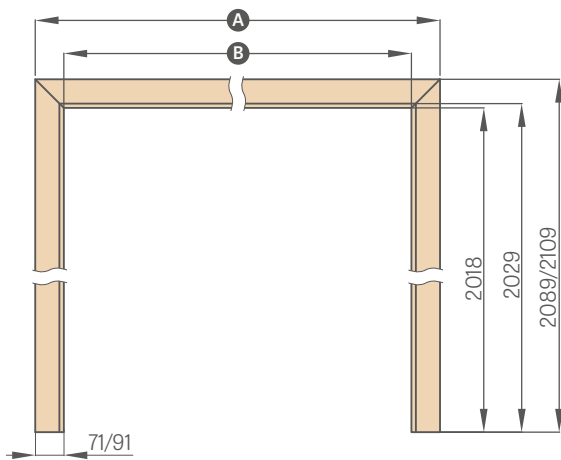

	"60"	"70"	"80"	"90"	"100"	"110"	"120"
A	746 / 786	846 / 886	946 / 986	1046 / 1086	1146 / 1186	1246 / 1286	1346 / 1386
B	604	704	804	904	1004	1104	1204

	"130"	"140"	"150"	"160"	"170"	"180"	"190"
A	1446 / 1486	1546 / 1586	1646 / 1686	1746 / 1786	1846 / 1886	1946 / 1986	2046 / 2086
B	1304	1404	1504	1604	1704	1804	1904

architrave 6 cm / architrave 8 cm

CASING DOOR FRAME

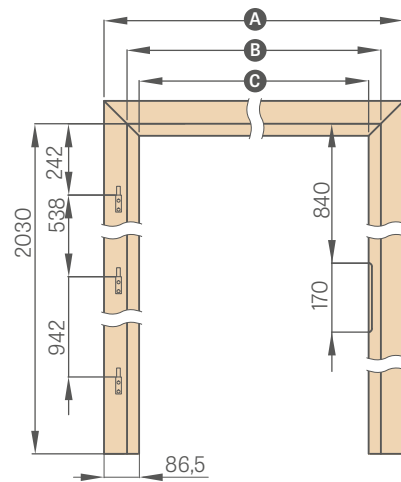

	"60"	"70"	"80"	"90"	"100"
A	737	837	937	1037	1137
B	624	724	824	924	1024
C	564	664	764	864	964

FIXED DOOR FRAME

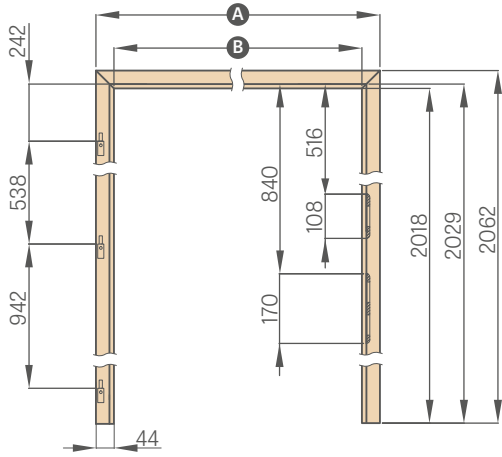

	"60"	"70"	"80"	"90"	"100"	"110"
A	692	792	892	992	1092	1192
B	604	704	804	904	1004	1104

REVERSE DOOR FRAME

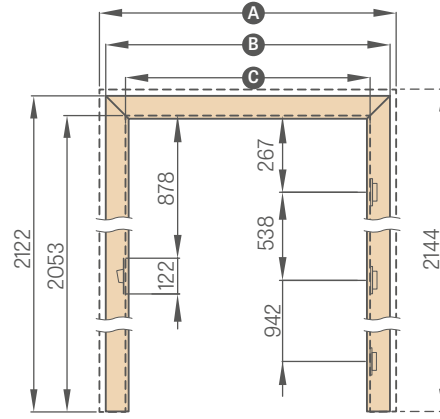

Widths 60N, 70N, 90N only available for ALTAMURA 1, BALDUR 1 and UNO PREMIUM models

	"60N"	"60"	"70N"	"70"	"80N"	"80"	"90N"	"90"	"100"	"110"
A	810	834	910	934	1010	1034	1110	1134	1234	1334
B	766	791	866	891	966	991	1066	1091	1191	1291
C	628	652	728	752	828	852	928	952	1052	1152

FIXED DOOR FRAME FOR DOUBLE-LEAF DOORS

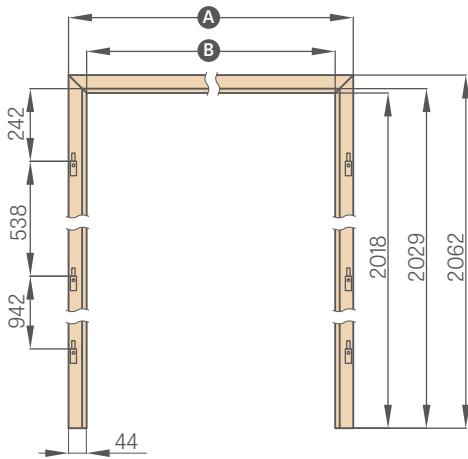

	"90"	"100"	"110"	"120"	"130"	"140"
A	1038	1138	1238	1338	1438	1538
B	950	1050	1150	1250	1350	1450

	"150"	"160"	"170"	"180"	"190"
A	1638	1738	1838	1938	2038
B	1550	1650	1750	1850	1950

ADJUSTABLE REBATED DOOR FRAME FOR DOUBLE-LEAF DOORS

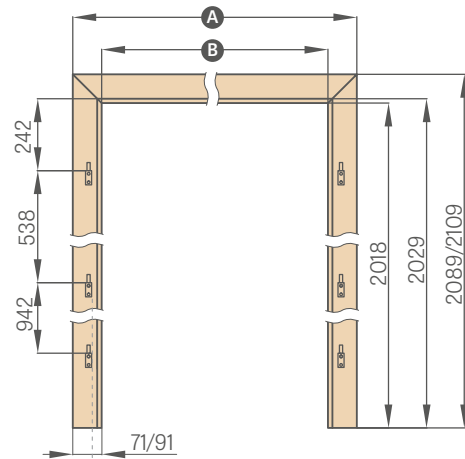

	"90"	"100"	"110"	"120"	"130"	"140"
A	1092/1132	1192/1232	1292/1332	1392/1432	1492/1532	1592/1632
B	950	1050	1150	1250	1350	1450

	"150"	"160"	"170"	"180"	"190"
A	1692/1732	1792/1832	1892/1932	1992/2032	2092/2132
B	1550	1650	1750	1850	1950

architrave 6 cm / architrave 8 cm

FIXED DOOR FRAME FOR GLASS DOORS

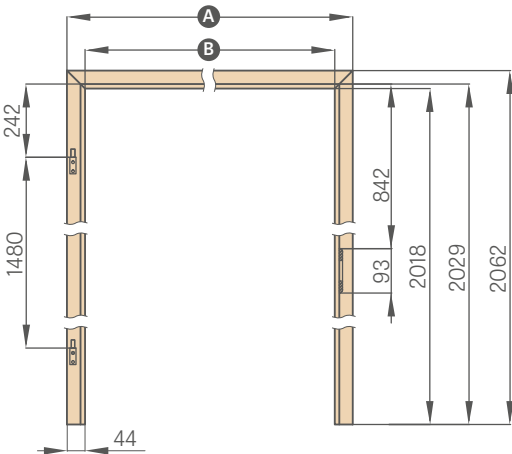

	"60"	"70"	"80"	"90"
A	692	792	892	992
B	604	704	804	904

10 mm pin hinge for glass panes frames

ADJUSTABLE REBATED DOOR FRAME FOR GLASS DOORS

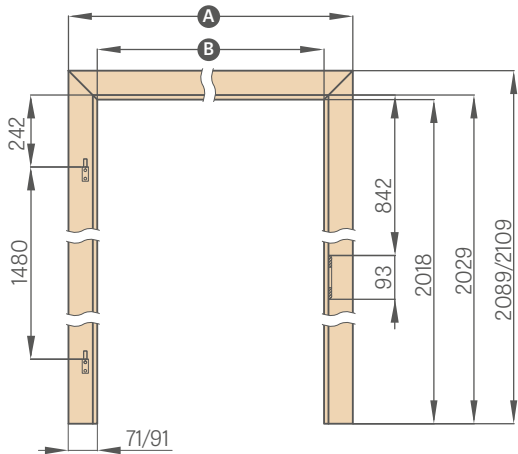

	"60"	"70"	"80"	"90"
A	746/786	846/886	946/986	1046/1086
B	604	704	804	904

architrave 6 cm / architrave 8 cm

TUNNEL TYPE ADJUSTABLE DOOR FRAME

REBATED / NON-REBATED

TUNNEL TYPE DOOR FRAMES

The tunnel type door frames are adjustable door frames without any hardware. They are made with a top strip and two vertical strips.

They can be used to finish door openings and safeguard wall corners, but mainly are fitted for interior decoration effects.

The tunnel type adjustable rebated door frames are also used in the ERKADO sliding systems.

The tunnel type adjustable non-rebated door frames are not used in the sliding systems.

Depending on the system, we use the following rebated tunnels:

TUNNEL FOR SP1N	Wall-mounted single sliding system
TUNNEL FOR SP2N	Wall-mounted double sliding system
TUNNEL FOR SP1C.100	Single "100" pocket sliding system
TUNNEL FOR SP2C.100	Double "100" pocket sliding system
TUNNEL FOR SP1C.125	Single "125" pocket sliding system
TUNNEL FOR SP2C.125	Double "125" pocket sliding system
Encasing ZN1	Wall encasing for one side of the single door systems SP1C.100 and SP1C.125
Encasing ZN2	Wall encasing for one side of the double door systems SP2C.100 i SP2C.125

ADJUSTABLE REBATED TUNNELS

	"60"	"70"	"80"	"90"	"100"	"110"	"120"	"130"	"140"	"150"	"160"	"170"	"180"	"190"
opening width in the wall	688	788	888	988	1088	1188	1288	1388	1488	1588	1688	1788	1888	1988
tunnel outer width	648	748	848	948	1048	1148	1248	1348	1448	1548	1648	1748	1848	1948
tunnel opening width	604	704	804	904	1004	1104	1204	1304	1404	1504	1604	1704	1804	1904
tunnel cover width architrave 6 cm / architrave 8 cm	746 / 786	846 / 886	946 / 986	1046 / 1086	1146 / 1186	1246 / 1286	1346 / 1386	1446 / 1486	1546 / 1586	1646 / 1686	1746 / 1786	1846 / 1886	1946 / 1986	2046 / 2086
opening height in the wall	2060 (2142) ¹⁾													
tunnel outer height	2040 (2122) ¹⁾													
tunnel opening height	2018 (2100) ¹⁾													
tunnel cover height architrave 6 cm / architrave 8 cm	2089 / 2109 (2171 / 2191) ¹⁾													

ADJUSTABLE NON-REBATED TUNNELS

	"60"	"70"	"80N"	"80"	"90"	"100"	"110"	"120"	"130"	"140"	"150"	"160"	"170"	"180"
opening width in the wall	713	813	888	913	1013	1113	1213	1313	1413	1513	1613	1713	1813	1913
tunnel outer width	673	773	849	873	973	1073	1173	1273	1373	1473	1573	1673	1773	1873
tunnel opening width	629	729	805	829	929	1029	1129	1229	1329	1429	1529	1629	1729	1829
tunnel cover width architrave 6 cm / architrave 8 cm	771 / 811	871 / 911	947 / 987	971 / 1011	1071 / 1111	1171 / 1211	1271 / 1311	1371 / 1411	1471 / 1511	1571 / 1611	1671 / 1711	1771 / 1811	1871 / 1911	1971 / 2011
opening height in the wall	2073 (2155) ¹⁾													
tunnel outer height	2053 (2135) ¹⁾													
tunnel opening height	2031 (2113) ¹⁾													
tunnel cover height architrave 6 cm / architrave 8 cm	2102 / 2122 (2184 / 2204) ¹⁾													

¹⁾ PL2112 standard



STEEL DOOR FRAME

FOR GRAF STILE PANELLED, FLUSH & GLASS DOORS

ADJUSTABLE STEEL DOOR FRAME (OVERLAPPING), 1.5 mm wide sheet metal 1.5 mm

welded and coated in RAL 9003, 9010, 9016, 8003, 8017, 7016, 7022, 9005, 7047, 1001

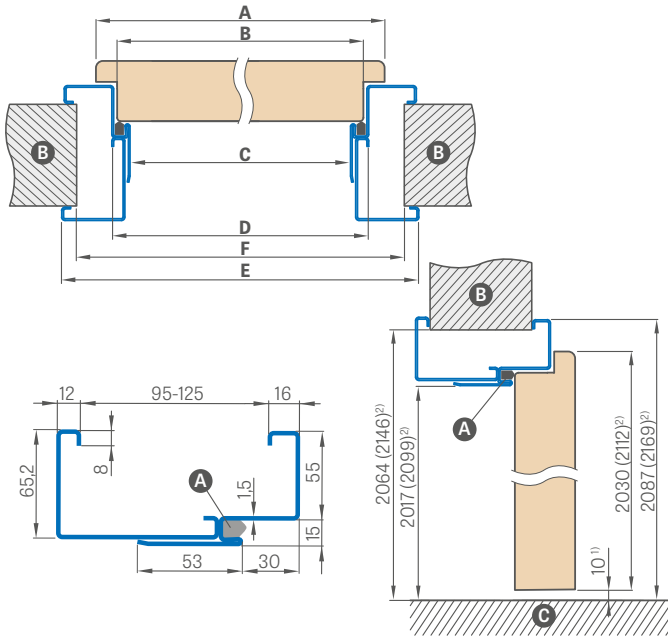

SQUARE STEEL DOOR FRAME (LARGE), sheet metal 1.2 mm

welded and coated in RAL 9003, 9010, 9016, 8003, 8017, 7016, 7022, 9005, 7047, 1001

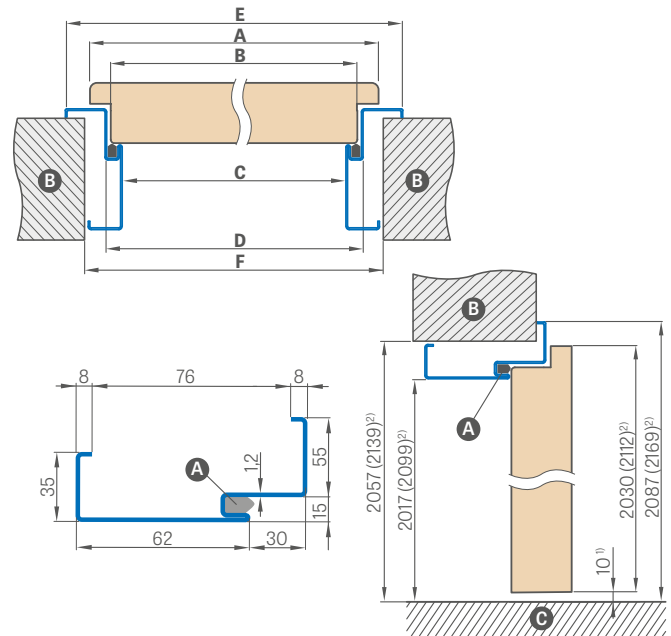

¹⁾ allowable deviation due to frame dimensional tolerance of +- 3 mm (we recommend to check before installation) ²⁾ 2112 STANDARD

Door width	A	B	C	D	E	F
"60"	644	617	601	631	741	695
"70"	744	717	701	731	841	795
"80"	844	817	801	831	941	895
"90"	944	917	901	931	1041	995
"100"	1044	1017	1001	1031	1141	1095
"110"	1144	1117	1101	1131	1241	1195

Door width	A	B	C	D	E	F
"60"	644	617	601	631	741	691
"70"	744	717	701	731	841	791
"80"	844	817	801	831	941	891
"90"	944	917	901	931	1041	991
"100"	1044	1017	1001	1031	1141	1091
"110"	1144	1117	1101	1131	1241	1191

Adjustment Range min-max (mm)	RAL 9003, 9010, 9016, 8003, 8017, 7016, 7022, 9005, 7047, 1001
95-125	
125-155	
155-185	
185-215	
215-245	
245-275	
275-305	

RAL



FITTING THE SQUARE FRAME

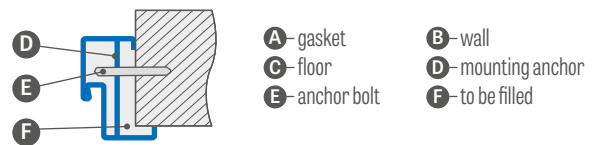

ADDITIONAL CHARGES

electric door strike	
door closer reinforcement	
galvanised sheet steel	+10%
adjustable frame "100" or "110"	
fixed frame "100" or "110"	
door frame for double doors	Bespoke pricing
standard 2112	15% additional charge
non-typical RAL (rare, intensive, pearly and metallic colours not included)	10% additional charge

¹⁾ for an additional charge +10%

STEEL DOOR FRAME

NON-REBATED, FOR FLUSH AND PANELLED LEAVES

ADJUSTABLE STEEL NON-REBATED DOOR FRAME (OVERLAPPING), sheet metal, thickness: 1.5 mm

welded and coated in RAL 9003, 9010, 9016, 8003, 8017, 7016, 7022, 9005, 7047, 1001

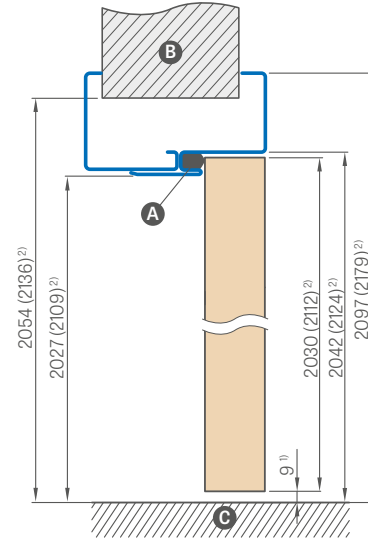
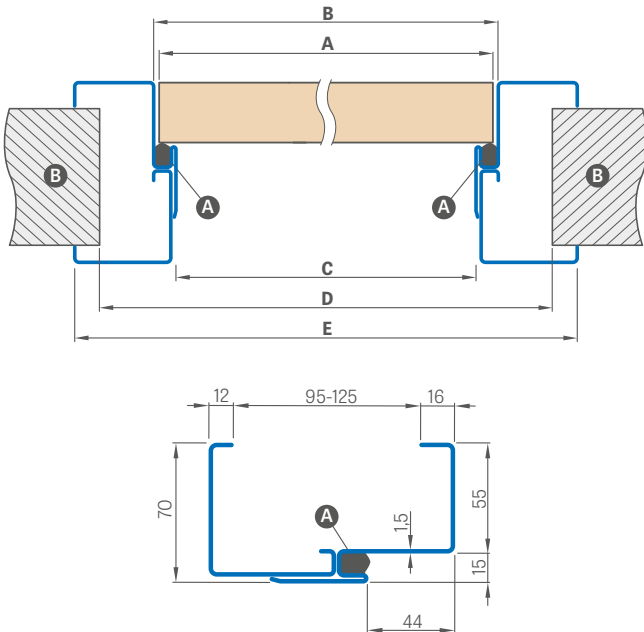

¹⁾ allowable deviation due to frame dimensional tolerance of ± 3 mm (we recommend to check before installation)

²⁾ 2112 Standard

Adjustment Range min-max (mm)	RAL 9003, 9010, 9016, 8003, 8017, 7016, 7022, 9005, 7047, 1001
95-125	
125-155	
155-185	
185-215	
215-245	
245-275	
275-305	

Door width	A	B	C	D	E
"60"	644	650	620	710	760
"70"	744	750	720	810	860
"80"	844	850	820	910	960
"90"	944	950	920	1010	1060
"100"	1044	1050	1020	1110	1160
"110"	1144	1150	1120	1210	1260

A - gasket **B** - wall **C** - floor

Door frames come with three hinges as standard.

ADDITIONAL CHARGES

door closer reinforcement

galvanised sheet steel +10%

adjustable frame "100" or "110"

standard 2112 15% additional charge

non-typical RAL (rare, intensive, pearly and metallic colours not included)

10% additional charge

RAL



RAL 9003¹⁾ RAL 9010 RAL 9016 RAL 8003 RAL 8017 RAL 7016 RAL 7022²⁾ RAL 9005¹⁾ RAL 7047 RAL 1001

¹⁾ for an additional charge +10%



ADJUSTABLE OVERLAY DOOR FRAME

FOR STEEL DOOR FRAMES

HANDLE POSITION IN AN OVERLAY DOOR FRAME

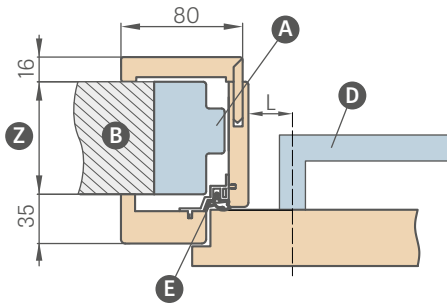

L – distance between the handle centre line and the frame strip edge

L = 28 mm for panelled and flush doors (available with all interior door handles presented in the range)

NOTE: Check the handle backplate/escutcheon dimensions before installation.

Adjustable overlay door frame of over 200 mm consists of two components, and a frame of over 320 mm consists of three components.

AVAILABLE WIDTHS FOR OVERLAY FRAMES:

60 70 80 90 100

Adjustment range min-max (mm)	ADJUSTABLE CASING DOOR FRAME	
	GREKO	ST CPL & PREMIUM
1 component	80-100	
	100-120	
	120-140	
	140-160	
	160-180	
2 components	180-200	
	200-220	
	220-240	
	240-260	
	260-280	
3 components	280-300	
	300-320	
	320-340	
	340-360	
	360-380	
	380-400	
	400-420	
420-440		

OVERLAY DOOR FRAME DIAGRAM

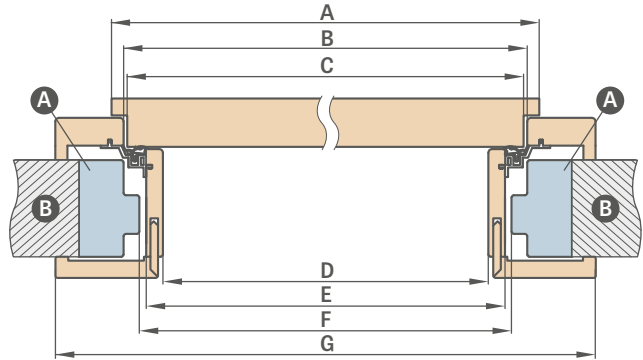

Door width	A	B	C	D	E	F	G
"60"	644	624	618	564	592	598	733
"70"	744	724	718	664	692	698	833
"80"	844	824	818	764	792	798	933
"90"	944	924	918	864	892	898	1033
"100"	1044	1024	1018	964	992	998	1133

F – min dimension of the steel frame opening, on which to fit an overlay door frame.

This dimension can exceed the recommended one by max 20 mm. For greater frame opening, ensure the architraves cover the wall appropriately.

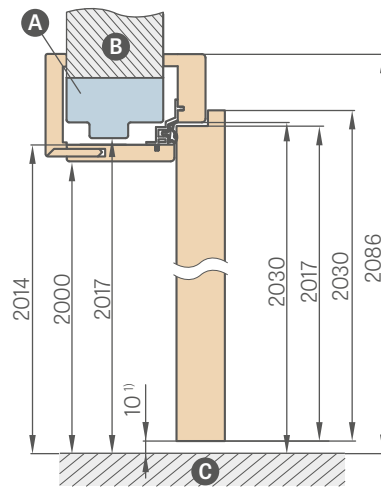

¹⁾ allowable deviation due to frame dimensional tolerance of ± 3 mm (we recommend to check before installation)

- A** – steel door frame
- B** – wall
- C** – floor
- D** – handle
- E** – aluminium profile with gasket
- Z** – range from 80 mm to 255 mm

- 120 mm and 55 mm extension for the top frame – for an additional charge
- standard square for the casing door frame – for an additional charge
- square with an extended tongue – for an additional charge

- tunnel type door frame for widths of 60, 70, 80, 90, 100 are at the price of the adjustable overlay door frame.
- the tunnel is of the same dimensions as the overlay door frame and is not pre-drilled for hinge or door striker plate, but is supplied with a gasket
- prices of door frames for double-leaf doors + 30%

REVERSE DOOR FRAME

REVERSE DOOR LEAVES

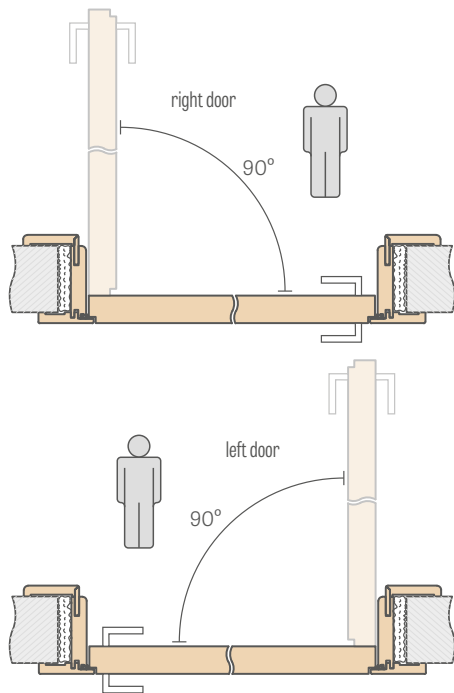

ADJUSTMENT RANGE FOR REVERSE DOOR FRAME

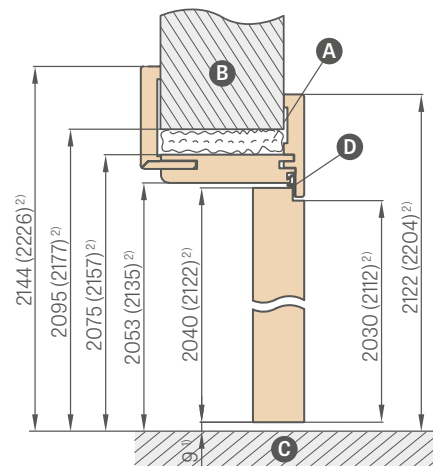
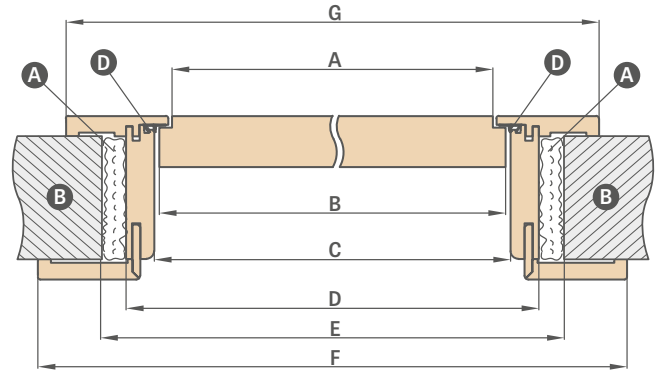
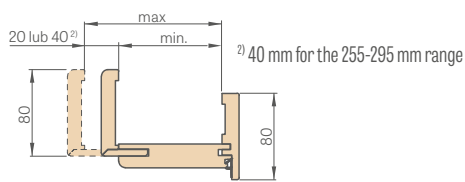

¹⁾ allowable deviation due to frame dimensional tolerance of ± 3 mm (we recommend to check before installation)

²⁾ Standard PL2112

Ⓐ-foam Ⓑ-wall Ⓒ-floor Ⓓ- rubber gasket

Adjustment range min-max (mm)	REVERSE DOOR FRAME		
	GREKO	ST CPL & PREMIUM	PAINTED
75-95			
95-115			
115-135			
135-155			
155-175			
175-195			
195-215			
215-235			
235-255			
255-295			
295-315			
315-335			
335-355			

Door width	A	B	C	D	E	F	G
*60N ³⁾	600	620	628	672	700	810	766
*60"	624	644	652	696	736	834	791
*70N ³⁾	700	720	728	772	800	910	866
*70"	724	744	752	796	836	934	891
*80N"	800	820	828	872	900	1010	966
*80"	824	844	852	896	936	1034	991
*90N ³⁾	900	920	928	972	1000	1110	1066
*90"	924	944	952	996	1036	1134	1091
*100"	1024	1044	1052	1096	1136	1234	1191
*110"	1124	1144	1152	1196	1236	1334	1291

³⁾ widths 60N, 70N, 90N only available for ALTAMURA 1, BALDUR 1 and UNO PREMIUM models

NOTE: The working range of frame will be reduced by 3 mm (for single-sided use) or 6 mm (for double-sided use) when a set (crosshead + pilasters) for the reverse adjustable frame is selected. Example: assume a 140 mm thick wall with a single-sided set to be 143mm thick, while with a double-sided set to be 146 mm thick, and look for a corresponding masonry coverage in the table for rebated frames (p. 171), non-rebated frames (p. 168) or reverse frames (p. 167).

- the frame for reverse doors is available as a standard with 8 cm square joined at 45 degrees or 90 degrees for an additional charge (not available for 75-95 mm)
- the frame includes two mortise hinges invisible when the leaf is closed or an optional third hinge for an additional charge
- available facing layers within the colour group: GREKO, PREMIUM, ST CPL and TITANIUM WHITE UV varnish
- option to use black, white or golden hinges and strike plate – for an additional charge
- changing the range by +20 mm (available in the ranges from 135-155 mm to 235-255 mm) – for an additional charge
- 120 mm and 55 mm extension for laminated or painted reverse frame – for an additional charge
- movable square with 2 cm longer tongue and standard square for adjustable frames with all laminates and lacquered – for an additional charge
- the door frame above 295 mm is composed of two parts
- top panels can be glued to the wall for an additional charge page 152
- PL2112 standard additional charge 15 %

ADJUSTABLE DOOR FRAME

NON-REBATED DOOR LEAVES

ADJUSTABLE DOOR FRAME RANGE 80-95mm

architrave 6 cm / architrave 8 cm

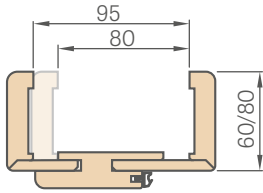

The square tongue is to be trimmed by a customer to required size, for door frames within 80-95mm range

DOOR FRAME JOINTS

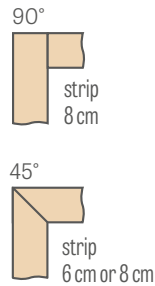

ADJUSTABLE DOOR FRAME DIAGRAM

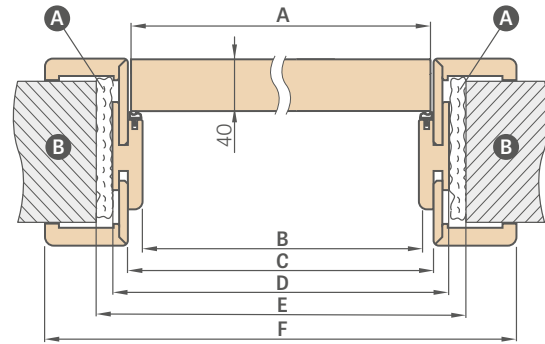

ADJUSTABLE DOOR FRAME RANGE

architrave 6 cm / architrave 8 cm

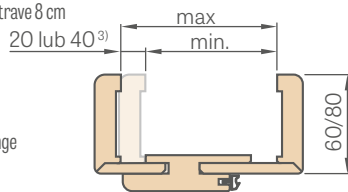

³⁾ 40 mm for the 295-335 mm range

Door width	A	B	C	D	E	F
"60N" ³⁾	620	605	627	649	688	747*/787**
"60"	644	629	651	673	714	771*/811**
"65"	695	680	702	724	764	822*/862**
"70N" ³⁾	720	705	727	749	788	847*/887**
"70"	744	729	751	773	814	871*/911**
"75"	795	780	802	824	864	922*/962**
"80N"	820	805	827	849	888	947*/987**
"80"	844	829	851	873	914	971*/1011**
"85"	895	880	902	924	964	1022*/1062**
"90N" ³⁾	920	905	927	949	988	1047*/1087**
"90"	944	929	951	973	1014	1071*/1111**
"95"	995	980	1002	1024	1064	1122*/1162**
"100"	1044	1029	1051	1073	1114	1171*/1211**
"110"	1144	1129	1151	1173	1214	1271*/1311**

* architrave 6 cm / ** architrave 8 cm

Adjustment range min-max (mm)	ADJUSTABLE DOOR FRAME architraves 6 cm & 8 cm			
	GREKO	ST CPL & PREMIUM	CPL 0.2	PAINTED
80-95				
95-115				
115-135				
135-155				
155-175				
175-195				
195-215				
215-235				
235-255				
255-275				
275-295				
295-315				
315-355				
355-375				
375-395				
395-415				

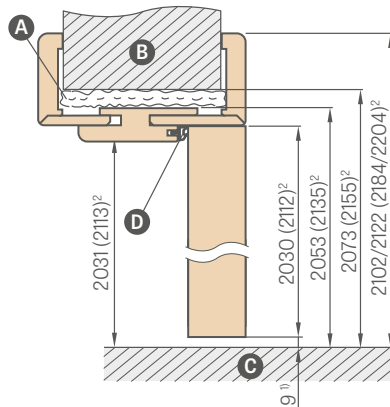

¹⁾ allowable deviation due to frame dimensional tolerance of +- 3 mm (we recommend to check before installation)

²⁾ PL2112 Standard for an additional charge of 15%

³⁾ widths 60N, 70N, 80N, 90N only available for ALTAMURA 1, BALDUR 1 and UNO PREMIUM models

NOTE: The working range of frame will be reduced by 3 mm (for single-sided use) or 6 mm (for double-sided use) when a set (crosshead + pilasters) for the non-rebated adjustable frame is selected. Example: assume a 140 mm thick wall with a single-sided set to be 143mm thick, while with a double-sided set to be 146 mm thick, and look for a corresponding masonry coverage in the table for rebated frames (p. 171), non-rebated frames (p. 168) or reverse frames (p. 167).

- PL2112 standard frame +15% on the frame price before additional charges
- adjustable rebate-free door frame in CPL0.2 is also used in combination with doors in CPL0.7
- option to use black, white or golden hinges and strike plate – for an additional charge
- joints at 90 degrees possible for door frames with the 8 cm architraves only; additional charge for frame joints at 90°
- the door frame above 335 mm is composed of two parts
- prices of adjustable door frames for double doors + 30%
- 120 mm and 55 mm extension for non-rebated door frame, laminated, CPL 0.2 and lacquered – for an additional charge
- adjustable square with 2 cm extended tongue and standard square for adjustable frames available in all facings and in CPL0.2 and lacquer – for an additional charge – for 6 cm and 8 cm architraves
- tunnel type door frame for widths of 60, 70, 80N, 80, 90, 100 are at the price of the adjustable rebated door frame (see table p. 183)
- tunnel type door frame for widths of 110, 120, 130, 140, 150, 160, 170, 180, 190 are at the price of the adjustable door frame for rebated double doors (see table p. 183)
- top panels glued to the wall (only for frames with 8 cm corner) – p. 152
- electric door strike (only available for latch and pin lock) – for an additional charge
- changing the range by +20 mm (available in the ranges from 135-155 mm to 295-315 mm) – for an additional charge
- the door frame contains two so-called hidden hinges, invisible when the door leaf is closed, or an optional third hinge at an additional cost

FIXED DOOR FRAME

REBATED DOOR LEAVES

FIXED DOOR FRAME

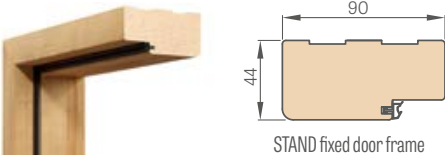

GREKO	
ST CPL & PREMIUM	
CPL 0.2	
PAINTED	

ARCHITRAVES 8 mm

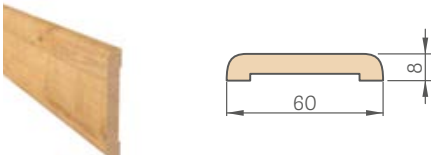

GREKO	
ST CPL & PREMIUM	
CPL 0.2	
PAINTED	

Price for a set of 2 pcs. x 213.5 cm and 1 pc. x 112 cm (for door leaves from "60" to "90")
 Price for a set of 3 pcs. x 213.5 cm (for door leaves from "100" to "190")

QUARTER ROUND



GREKO	
ST CPL & PREMIUM	
PAINTED	

Price for a set of 2 pcs. x 211.5 cm and 1 pc. x 106.5 cm (for door leaves from "60" to "90")
 Price for a set of 3 pcs. x 211.5 cm (for door leaves from "100" to "190")

ELECTRIC DOOR STRIKE

Technical specifications on p. 149



SKIRTING BOARD length 2.40 lin.m.

- laminated
- lacquered

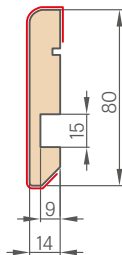

- the skirting board is made of moisture resistant MDF board. Available variants: TITANIUM WHITE UV paint, laminates: GREKO, ST CPL, PREMIUM and in base laminate to be paint coated.
- fitting method: bonding to wall

CLIP-ON SQUARE 6 cm and 8 cm (3 pcs. of clips supplied)



GREKO	
ST CPL & PREMIUM	
CPL 0.2	
PAINTED	

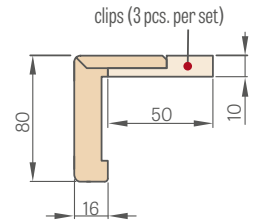

ARCHITRAVES 16 mm

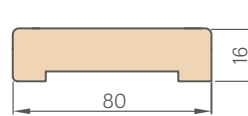

GREKO	
ST CPL & PREMIUM	
CPL 0.2	
PAINTED	

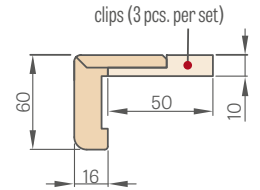

Price for a set of 2 pcs. x 214.5 cm and 1 pc. x 112 cm (for door leaves from "60" to "80")
 Price for a set of 3 pcs. x 214.5 cm (for door leaves from "90" to "180")

STAND FIXED FRAME

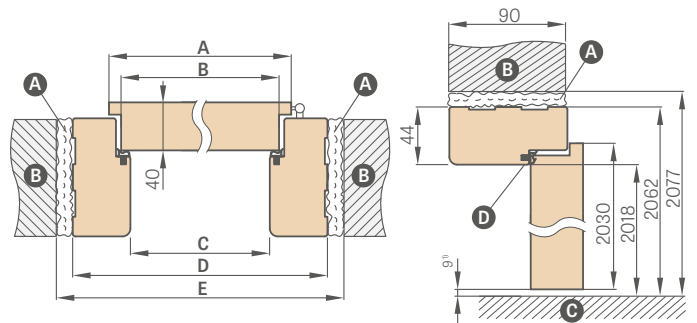

¹⁾ allowable deviation due to frame dimensional tolerance of +- 3 mm (we recommend to check before installation)

Door width	A	B	C	D	E
"60"	644	618	604	692	722
"65"	695	669	655	743	773
"70"	744	718	704	792	822
"75"	795	769	755	843	873
"80"	844	818	804	892	922
"85"	895	869	855	943	973
"90"	944	918	904	992	1022
"95"	995	969	955	1043	1073
"100"	1044	1018	1004	1092	1122
"110"	1144	1118	1104	1192	1222

Ⓐ-foam Ⓑ-wall Ⓒ-floor Ⓓ-rubber gasket

- fixed door frame for double-leaf doors + 30%
- non-rebated fixed door frame - NA
- the fixed frame, architrave and clip-on square in CPL 0.2 are also used in the set for door leaves in CPL 0.7
- black strike plate only available for GRAF glass door frames - for an additional charge



ADJUSTABLE DOOR FRAME

REBATED DOOR LEAVES



ADJUSTABLE DOOR FRAME
ABOVE 340 mm

Adjustable door frame above 340 mm consists of two elements.

ADJUSTABLE DOOR FRAME RANGE

architrave 6 cm / architrave 8 cm

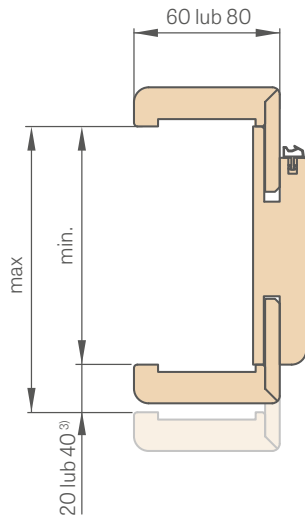

³⁾ 40 mm for the 300-340 mm range

The square tongue is to be trimmed by a customer to required size, for door frames within 65-80mm range

DOOR FRAME JOINTS

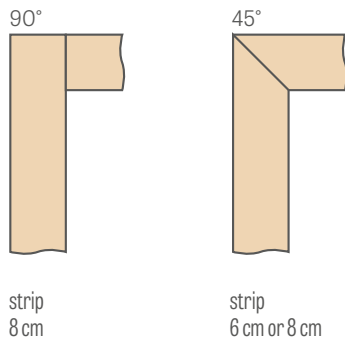

ADJUSTABLE DOOR FRAME DIAGRAM

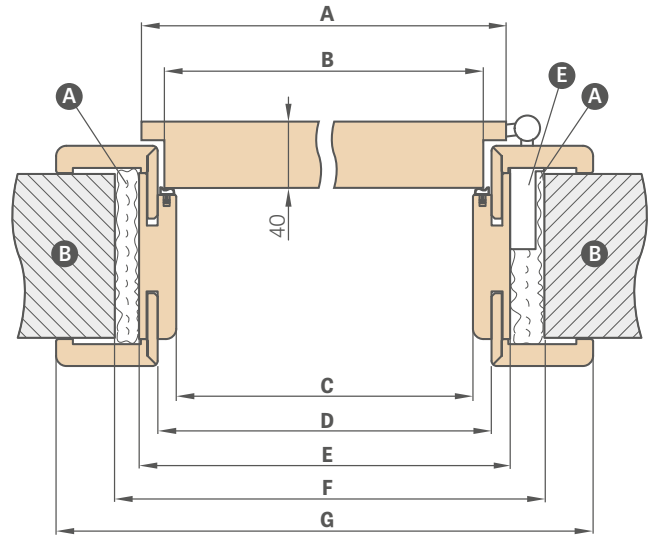

Door width	A	B	C	D	E	F	G
"60"	644	618	604	626	648	688	746*/786**
"65"	695	669	655	677	699	739	797*/837**
"70"	744	718	704	726	748	788	846*/886**
"75"	795	769	755	777	799	839	897*/937**
"80"	844	818	804	826	848	888	946*/986**
"85"	895	869	855	877	899	939	997*/1037**
"90"	944	918	904	926	948	988	1046*/1086**
"95"	995	969	955	977	999	1039	1097*/1137**
"100"	1044	1018	1004	1026	1048	1088	1146*/1186**
"110"	1144	1118	1104	1126	1148	1188	1246*/1286**

* architrave 6 cm / ** architrave 8 cm

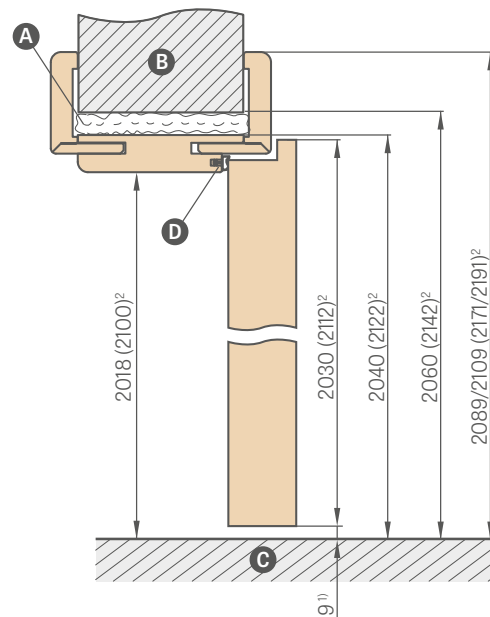

¹⁾ allowable deviation due to frame dimensional tolerance of +- 3 mm (we recommend to check before installation)

²⁾ PL2112 Standard for an additional charge of 15%

- A** - foam
- B** - wall
- C** - floor
- D** - rubber gasket
- E** - hinge socket



installation video:
<https://youtu.be/habWXyCI98c>

Adjustment range min-max (mm)	ADJUSTABLE DOOR FRAME AND TUNNEL architraves 6 cm & 8 cm			
	GREKO	ST CPL & PREMIUM	CPL 0.2	PAINTED
1 component	65-80			
	80-100			
	100-120			
	120-140			
	140-160			
	160-180			
	180-200			
	200-220			
	220-240			
	240-260			
2 components	260-280			
	280-300			
	300-340			
	340-360			
	360-380			
	380-400			
	400-420			

NOTE: The working range of frame will be reduced by 3 mm (for single-sided use) or 6 mm (for double-sided use) when a set (crosshead + pilasters) for the rebated adjustable frame is selected. Example: assume a 140 mm thick wall with a single-sided set to be 143mm thick, while with a double-sided set to be 146 mm thick, and look for a corresponding masonry coverage in the table for rebated frames (p. 171), non-rebated frames (p. 168) or reverse frames (p. 167).

- PL2112 standard frame **+15%** on the frame price before additional charges
- the CPL 0.2 adjustable rebated frame is also used with CPL 0.7 door leaves
- joints at 90 degrees possible for door frames with the 8 cm architraves only; additional charge for joining at 90 degrees
- electric door strike – for an additional charge
- reinforcement for door closer – for an additional charge
- prices of fixed and adjustable door frames for double doors **+ 30%**
- adjustable square with 2 cm extended tongue and standard square for adjustable frames available in all facings and in CPL 0.2 and lacquer – for an additional charge – for 6 cm and 8 cm architraves
- black or white strike plate only available for GRAF glass door frames – for an additional charge
- 120 mm and 55 mm extension for adjustable laminated frame and CPL 0.2 and painted frame – for an additional charge
- possibility to make door frames ranging between 0 and 520 mm – an additional charge for each 2 cm is PLN 80, relative to the frame price of PLN 400-420 mm
- tunnel type door frame for both rebated and non-rebated door widths of 60, 70, 80N (only non-rebated), 80, 90, 100 are at the price of the rebated adjustable door frames.
- tunnel type door frame for both rebated and non-rebated door widths of 110, 120, 130, 140, 150, 160, 170, 180, 190 are at the price of the adjustable door frame for rebated double doors
- top panels glued to the wall (only for frames with 8 cm corner) – p. 152
- changing the range by +20 mm (available in the ranges from 120-140 mm to 280-300 mm) – for an additional charge

The warranty certificate and assembly manual are attached with products.
This Product Catalogue is for reference only, and shows current prices and product availability.
The manufacturer reserves the right to modify prices and product availability without prior notice.
Actual colours in colour charts can differ from these indicated in this Product Catalogue.
Please consult the colours with original colour charts available at our dealer centres.
The photos in the Product Catalogue are for reference only and dimensional proportions of some components can occur for different door leaf widths.
We reserve the right to printing mistakes.
The Product Catalogue is not an offer in legal terms and is published only for reference.

Edition I/2025/C applies from 1.09.2025.

The door should be selected on the basis of a basic design of a facility, prepared considering all applicable standards and provisions of law, as well as frequency and conditions of use. ERKADO offers several variants, but leaves the final choice to the Buyer, because only the Buyer or their representatives knows the purpose and conditions of use for the product to be ordered.

Certificates can be downloaded from our website www.erkado.pl